

PURSELL

Manufacturing Corp.



Holiday Sales

2019 Christmas Tree Supply Catalog

FREE SHIPPING



on invoices over \$2,500*

*see pg. 7 for exceptions

1-888-487-8288

(719) 530-9096

Fax: (719) 530-9097

pursellmfg.com

sales@pursellmfg.com

Contents



pg. 14-15

pg. 11



pg. 16

pg. 26-33



About Us	3-5	Pin Stands	18-19
Advent Rings	37	Pine Cones	39
Aprons	44	Plastic Stands	16-17
Bags	12	Poly Tubing	33
Balers	36	Post/Lot Signs	41
Banners & Promotion	8-10	Preservatives	11
Berries, holly	39	Price Breaks, guide	7
Bigfoot Stands	24-25	Pull Bows	12,38
Blower Motor	32	Pumpkin Carving Kits	47
Bowls, nail on	23	Rack-Poly Tubing	33
Bowls, Rebar	19	Rebar Accessories	19-21
Bows	12,38	Rebar Stands & Bowls	18-20
Braces, wood	22	Reindeer	14-15
Brushes, blower motor	32	Removal Bags	12
Burlap	43	Resale Items	11-15
Carving Kits, Pumpkin	47	Ribbon	38
Chucks, drills	20	Ring Knives	44
Cinco Stands	16	Rubber Bands, snappy	44
Clamp Machines (wreath)	37	Rudi's Cuties (Reindeer)	14-15
Clamps (tree display)	21	Sales Tags	40
Clusters, berry	39	Seal Pads	23
Colorant, flock	28	Shade Cloth	43
Colored Flock	27	Shaker	45
Counters, Tally	44	Shark-Fin Flags	10
Criterion 33 Flock	26	Shipping guide	6-7
Davis Stands	24-25	Signs, lot/species	41
Deer, Log	14-15	Signs-banners	8-10
Directional Lot Signs	41	Snappy Ties	44
Display Arms	21	Snow Force Flock Machine	29-30
Display systems, spike	21	Snowmen	14-15
Drill Bits	20	Sold tags	40
Drill Machine	20	Species tags	40
Educational tree tags	40	Species Signs	41
End Caps	20	Speedy Wrap. Poly	33
Flagging Tape	46	Spike Bowls	19
Flags	10	Spike Display Systems	21
Flame Retardant	43	Spike Stands	18
Flame Retardant tags	40	Spray Snow	13, 39
Flock & Accessories	26-33	Tags	40
Flock Colorant and Tints	28	Tally counter	44
Flock Effects	28	Tape, Flagging	46
Flock Gun	32	Tennon Cutter	17
Flock Jugs, Retail	12	Thrifty Wire Stands	25
Flock Machinery & Parts	29-32	Tips, rebar	20
Floor Mats	13	TNI Netting	34-35
Free Shipping, details	6-7	Tree Clamps	21
Funnels	13	Tree Colorant	46
Glitter	28	Tree Mover (flock)	31
Golden Spike Rebar Stands	18-19	Tree Shaker	45
Grommets	19	Tree Shaped Tags	41
Hand Drill Adaptor	20	Tree Sorb	13
Hats	44	Tree Species Signs	41
Holly berries	39	Tree Stands	16-25
Hose Kit (for flock machine)	32	Tru-Cut Wood Stands	22-23
Knives, ring	44	Tru-Seal Water Bowls	23
Light Strings	42	Trunk Ties	44
Lil' Shakee	45	Turn Table	31
Load Divider/Separator	46	Twine	45
Lot Lights	42	Two-part tags	40
Lot Signs	41	Tying Twine	45
Mats	13	Tying Wire	39,44
Mica Flakes	28	Velvet Bows	38
Marathon 22 Flock	26	Water Bowls, Nail On	23
Nails	22	Watering Funnels	13
NCTA Tags	40	Wire Tree Stands	25
Netting	34-35	Wire, tying	39, 44
Noblett Stands	17	Wood Stands & Braces	22-23
Opalina Flakes	28	Wreath Clamps	37
Parts, Flock Equipment	29-32	Wreath Hangers	13
Pearlescent Flakes	28	Wreath Making Supplies	37-39
Pennants	10	Wreath Rings	37



pg. 8-10



pg. 12



pg. 18-19



pg. 34-35



pg. 37-38



Welcome To Our Catalog

Thank you to our many loyal customers and friends who have helped make Pursell Manufacturing the largest manufacturer of Christmas tree supplies in the world. We know that if you are successful, then we will be also. After 50 years, we are still excited about our upcoming season, and have been planning since last fall to make sure we are well positioned to help you have your best season ever!

If you are new to the Christmas Tree industry, we welcome you. You have the best source for getting started with supplies right in your hands. Please do not hesitate to contact us with any questions as we have helped hundreds of first time lot owners have profitable seasons. Please check out our "Retail Guide" at pursellmfg.com for an overview of products and what you might need to get started, as well as video demonstrations of how some of our products work.



Pursell family (2018)
Alan, Dawn & Isaak, Richard
Paul, Cynthia, Jonah, Brandon & Kayla

WHATS NEW?

PRODUCT UPDATES:



All new retail Flock Product, with display box and shaker dispensing lid. page 12



Bold new look to our preservative, page 13



LABOR SAVER
All new redesigned tree ties, page 45



Special Effects Snow: create winter scenes with the look of real snow, as used in movies, TV studios. Perfect for store fronts, windows and other applications. see page 26.



Removal bags updated with "GO GREEN, GET REAL" logo. page 12



Tree shaped tags with an all new look and material, page 40

WHAT YOU NEED TO KNOW ABOUT STATE SALES TAX

We want to avoid charging you sales tax. But because of new regulations across the USA, we have to request a sales tax exemption certificate from all of our customers **so that we can document the future sales tax exempt nature of your purchases.**

You may have heard about the court case South Dakota vs. Wayfair which has affected the entire country. States have started to change the rules of interstate commerce and require companies to document all sales tax exempt transactions across state lines. As a seller, **if we do not have a proper documentation, we are required to collect the tax** for the state in which the property or service is delivered.

Please fill out the adjacent Certificate of Exemption for your company for each Jurisdiction where your company does business (right). ** Please return this exempt form (or your own form) AND any other documentation (Certificate of Resale) as soon as possible by one of three methods below:

Email: erin@pursellmfg.com
Fax: 719-530-9097
Mail:
Pursell Mfg. Corp.
Attn: Sales Tax
PO Box 248
Poncha Springs, CO 81242

DON'T WAIT! Please fill out and send us this form to avoid required sales tax and possible order delays.

History of Pursell Mfg. Corp.



First facility near Grants Pass, Oregon about 1970



Loading wood stands on a truck of trees, 1973



Our current 48,000 sq. ft. manufacturing and distribution facility on 4 acres in
4 Poncha Springs, Colorado

In 1968 Pursell Manufacturing was founded by Bill and Richard Pursell (father & son) near Grants Pass, Oregon. From the start, their focus was on innovation, quality products, and superior customer service. Today our focus remains the same.

The Christmas Tree supply industry was revolutionized when Bill and Richard innovated a new process to mass produce high quality wooden Christmas Tree stands, which soon became the most popular method of standing trees in the American West. Pursell Manufacturing quickly became well known nationally as a reliable supplier of quality Christmas Tree supplies at a very competitive price.

Over the years that same dedication to innovation, quality, and service has been on display as we developed nail-on water bowls, tree preservative, flock, rebar stands and our own lines of netting. The acquisitions of TNI Netting in 2014 and Holiday Sales, Inc. in 2018 has continued to expand our presence in the Christmas Tree Lot Supply Industry and solidify our valuable long term relationships with both vendors and customers. Pursell Manufacturing takes great pride in what we produce. We put our name on many products, and we stand behind what we produce and distribute. This year we are well stocked on nearly 300 quality items for profitable Christmas Tree lots! We are ready to help you make your businesses more profitable.

Today Alan and Paul Pursell run Pursell Manufacturing, with the assistance of their father Richard out of Poncha Springs, CO, and Rockford, MN. As we look at the current stability of our organization, our combined 5-acre, 65,000 square foot facilities, and the great friendships we have built with our customers in the many years since 1968, we are reminded of what hard work, dedication to innovation, quality products, and superior customer service can do.

We are very blessed. We offer thanks to all our associates and customers over the past five decades! We hope you continue to choose Pursell Manufacturing for all your Christmas Tree lot supplies in the years to come.

Streamlined Sales Tax Agreement Certificate of Exemption

Do not send this form to the Streamlined Sales Tax Governing Board. Send the completed form to your supplier and keep a copy for your records.

This is a multi-state form. Not all states allow all exemptions listed on this form. Purchasers are responsible for knowing if they qualify to claim exemption from tax in the state that would otherwise be due tax on this sale. The seller may be required to provide this exemption certificate (or the data elements required on the form) to a state that would otherwise be due tax on this sale.

The purchaser will be held liable for any tax and interest, and possible civil and criminal penalties imposed by the member state, if the purchaser is not eligible to claim this exemption. A seller may not accept a certificate of exemption for an entity-based exemption on a sale made at a location operated by the seller within the designated state if the state does not allow such an entity-based exemption.

- Check if you are attaching the **Multistate Supplemental form**.
 If not, enter the **two-letter abbreviation** for the state under whose laws you are claiming exemption.
- Check if this certificate is for a **Single Purchase Certificate**. Enter the related invoice/purchase order # _____.

3.

Print or type

A. Name of purchaser _____

B. Business address _____ City _____ State _____ Zip code _____

C. Purchaser's tax ID number _____ State of Issue _____ Country of Issue _____

D. If no tax ID number, enter one of the following: FEIN _____

E. Driver's License Number/State Issued ID number _____ State of Issue _____

F. Foreign diplomat number _____

G. Name of seller from whom you are purchasing, leasing or renting _____

H. Seller's address _____ City _____ State _____ Zip code _____

4. Purchaser's Type of business. Circle the number that best describes your business.

Circle type of business

<input type="checkbox"/> 01 Accommodation and food services	<input type="checkbox"/> 11 Transportation and warehousing
<input type="checkbox"/> 02 Agriculture, forestry, fishing, hunting	<input type="checkbox"/> 12 Utilities
<input type="checkbox"/> 03 Construction	<input type="checkbox"/> 13 Wholesale trade
<input type="checkbox"/> 04 Finance and insurance	<input type="checkbox"/> 14 Business services
<input type="checkbox"/> 05 Information, publishing and communications	<input type="checkbox"/> 15 Professional services
<input type="checkbox"/> 06 Manufacturing	<input type="checkbox"/> 16 Education and health-care services
<input type="checkbox"/> 07 Mining	<input type="checkbox"/> 17 Nonprofit organization
<input type="checkbox"/> 08 Real estate	<input type="checkbox"/> 18 Government
<input type="checkbox"/> 09 Rental and leasing	<input type="checkbox"/> 19 Not a business
<input type="checkbox"/> 10 Retail trade	<input type="checkbox"/> 20 Other (explain) _____

5. Reason for exemption. Circle the letter that identifies the reason for the exemption.

Circle or check reason for exemption

A <input type="checkbox"/> Federal government (Department) _____	H <input type="checkbox"/> Agricultural Production # _____
B <input type="checkbox"/> State or local government (Name) _____	I <input type="checkbox"/> Industrial production/manufacturing # _____
C <input type="checkbox"/> Tribal government (Name) _____	J <input type="checkbox"/> Direct pay permit # _____
D <input type="checkbox"/> Foreign diplomat # _____	K <input type="checkbox"/> Direct Mail # _____
E <input type="checkbox"/> Charitable organization # _____	L <input type="checkbox"/> Other (Explain) _____
F <input type="checkbox"/> Religious organization # _____	M <input type="checkbox"/> Educational Organization # _____
G <input type="checkbox"/> Resale # _____	

6. Sign here

I declare that the information on this certificate is correct and complete to the best of my knowledge and belief.

Signature of authorized purchaser _____ Print name here _____ Title _____ Date _____

cut or tear along perforation

cut or tear along perforation

cut or tear along perforation

Pursell Manufacturing

2019 Order Form

For Fax or Phone Order Preparation

Order online at www.pursellmfg.com

or fill out and fax to:

(719) 530-9097

or call:

888-487-8288

Customer Information

<i>Billing</i>	<i>Shipping</i>
Company Name	Delivery Date Requested (M-F only, no delivery 11/28-12/1, Thur-Sun of Thanksgiving)
Your Name	Contact for Delivery-name/phone
Billing Address for Card City/St/Zip	Delivery Address
Email Address	Commercial Location <input type="checkbox"/> Non-commercial Location <input type="checkbox"/>
Billing Phone #	Do you need the truck to have a liftgate (\$35 fee)? <input type="checkbox"/> <small>(If liftgate is required but not requested you may incur delays, liftgate & redelivery fees)</small>
Billing Fax #	Delivery Phone # (if different from Billing Phone)
Payment Method (circle one) <div style="display: flex; justify-content: space-around;"> Visa Mastercard Discover Check </div>	Credit Card Info: Exp Date: / 3-Digit code: Account # _____ - _____ - _____ - _____ Name on Card (print)
Your Signature (required to process order)	

<i>Item Code</i>	<i>Quantity (ea)</i>	<i>Your Price (ea)</i>	<i>Total</i>

Payment: 1.5%/mo on past due accounts.
Seasonal merchandise is non-returnable

**If Order Total exceeds \$2,500
Shipping is
FREE**

Exceptions listed on pg 7 of catalog.

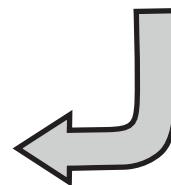

Order Total _____

cut or tear along perforation

cut or tear along perforation

cut or tear along perforation

The Pursell Advantage

What you'll get from us

Manufacturing, sales, and distribution directly from one source, one location.

The Source

- **FREE SHIPPING*** on orders over \$2,500!
Some exceptions apply, see pg. 6-7 for details and exceptions.
- **EXPERIENCE** We have been in this industry since 1968! Whether you are just getting started or have been around for a long time, we can help your business become more profitable.
- **PRICE** We understand that your success requires great prices, which we have because we buy in high volumes when commodity markets are low. Our buyers negotiate low rates and pass savings to you.
- **QUALITY PRODUCTS** We actually manufacture many of the products we sell. Our name is on the products we make, and we stand behind them. We know that the last thing you need to deal with in the rush of the season is faulty supplies. We take pride in our "old school" craftsmanship aided with modern technology.
- **EFFICIENCY** With our unmatched distribution system, orders are packed & shipped generally the same day, and delivered to most parts of the country within 2-4 days. The Northeast and Southeast require a few more days. Let us know what day you want your order delivered, and with a little notice we will make your desired delivery date.
- **WELL-STOCKED INVENTORY** We are prepared to ship nearly 300 items for your Christmas Tree lot needs - from one location at one time with disclosed handling fees (if any). Put all your needs on one order to save time and money.
- **INDUSTRY LEADING INNOVATION** Our commitment to finding better products and better processes sets us apart from our competitors.
- **SUPERIOR CUSTOMER SERVICE** Our team is experienced, and committed to excellence. We understand the value of time and money, and pride ourselves on getting things right the first time.
- **VOLUME DISCOUNTS** The more you order, the more you save. Price breaks go into effect when an individual customer order/shipment total hits one of three different Wholesale Price levels. See pricing chart page 7.



Decades of industry experience in sales and manufacturing gives an incredible background to draw from



Debbie, Erin and Alexis, our Sales & Customer Service team handles many of your questions and orders



Zach and Jason on flock production



Overlooking wood stand production floor



Production of our TNI knitted red and green netting



Augie and Tylea running the bottling line



Jonah, Blaine and Brian making our Golden Spike Rebar Stands

Our 5 acre facilities with 65,000 sf of warehouses are over-stocked with product to make sure we can get it to you when you need it. Our freight system can handle anything from small packages to multiple truckloads.



FREE SHIPPING*

on orders over \$2,500*

TIRED OF HIDDEN SHIPPING FEES?

We include shipping and handling in our prices so there are no surprises when you get your bill or statement. Many companies advertise what appears to be a low price, but hide additional shipping and handling charges (such as pallet fees, fuel surcharges, or drop ship fees) for you to discover later. We make sure to disclose any additional shipping costs or fees for special services such as liftgate or residential delivery, so you can TRULY compare and save.

KNOW YOUR DELIVERED PRICE!!



Special Handling Services & Fees

(may be required)

Lift Gate Service- \$35**

For palletized freight delivery only, not for small packages or full independent trucks.

**Costs depend on freight carrier and final destination.

There will be a 15% restocking fee for returned merchandise. Goods must be clean, complete, and in original packaging. Pursell Manufacturing not responsible for return shipping.

FREQUENTLY ASKED FREIGHT QUESTIONS

Q: How much will shipping cost?

A: Remember, orders over \$2,500 ship FREE (see page 7 for exceptions). If your order is less than \$2,500 (or distributor priced from our facility), freight cost depends on what you order, what it weighs, and how it will be shipped. We need to know what merchandise is being shipped so we can determine the best method, and what that will cost.

Q: Why are machinery and equipment items not included in free freight?

A: There just isn't any margin on equipment, and in order for our pricing to remain competitive, the prices we publish don't include free freight. However, if you order over \$2,500 in qualifying products, the equipment will ride along with it for free.

Q: When do I need a liftgate, and why is there a fee?

A: A liftgate is a special feature on a delivery truck that can help mechanically load or unload merchandise without a ramp, dock or forklift. It is basically a hydraulic lifting platform attached to the back of the truck. If the merchandise is palletized and you do not have unloading equipment, a liftgate will allow your order to be removed from the truck quickly and easily. Freight companies cannot allow your people to climb into the truck to unload your shipment piece by piece. A liftgate costs a little extra since the trucking company will have to make special arrangements to use proper equipment to deliver your order, but it is often far less complicated and less expensive than renting a forklift.

Q: How do I know if my order will be shipped as freight on a pallet or as a small package?

A: Our order processors will determine this when you place your order. The answer is determined by the weight and nature of the products you need. Generally, if your shipment is over 250 lbs, it will be cheaper and easier to freight it to you. Some products (bulky, overweight, etc.) must be palletized as they cannot be handled as a small package.

Q: Do you ship to Canada, Mexico, or overseas?

A: Yes, absolutely. Please call us for more details as each destination is handled differently.

Q: When will my merchandise arrive?

A: Many of our orders are taken early enough that we can schedule the merchandise to arrive to the desired location on the day you specify. We recommend ordering early to take advantage of this option. We can typically ship to the western 2/3rds of the country in 2-3 days, and 3-5 days to locations east of the Mississippi River. Thanksgiving weekend may present delays (no service Th-Sun). Expedited and overnight shipping may also be available in emergencies, please call.

* for exceptions to our free freight program, please see bottom of page 7 under our pricing guide.

PRICING GUIDE

How our pricing structure works



WHOLESALE PRICE
This is the base price for all orders under \$5,000. Remember, if your order is over \$2,500 we ship it to you **FREE!***

VOLUME DISCOUNTS
As your order goes over the \$5,000, \$10,000 or \$15,000 levels, the following price breaks apply, along with **FREE SHIPPING!***

FREE*
Shipping

Item	Code	Pack	Wholesale	>\$5,000	>\$10,000	>\$15,000
Pinnacle Flock	FLK	1	28.25	26.56	24.86	23.17

Note: Some listed prices are subject to change due to sudden market fluctuations. We maintain large inventories to prevent price changes, but we will inform you of changes in product prices if necessary when you order.

Fall 2019

Planning Calendar

Sun	Mon	Tues	Wed	Thur	Fri	Sat
November						
10/27	10/28	10/29	10/30	31	11/1	11/2
11/3	4	5	6	7	8	9
10	11	12	13	14	15	16
17	18	19	20	21	22	23
24	25	26	27	28	29	30
December						
12/1	12/2	12/3	12/4	12/5	12/6	12/7

PLAN AHEAD! ORDER EARLY CHOOSE A DELIVERY DATE

To insure that we have what you need and that your product arrives on time, **ORDER EARLY!** We process thousands of orders, and ship huge volumes from September through early December. **PLAN AHEAD!** We can take your order early and deliver on a date you choose. Help us make sure your product is in stock and arrives when you need it by ordering early and choosing a delivery date that suits you.

By mid November freight volumes are extremely high and inventories for some products may be low. Order earlier to insure product is available.

NO FREIGHT DELIVERIES 11/28-11/30 over Thanksgiving weekend. Deliveries 11/27 will be limited. Small package overnight deliveries are possible only on 11/29 and 11/30

* FREE SHIPPING EXCEPTIONS

- Machinery items** do not contribute toward price breaks or free shipping (priced from our location). However, if the balance of your invoice minus machinery cost totals over \$2,500, the machinery will be shipped free along with it. Machinery items include: Drill machines, Flock machinery (turn tables, tree movers, flock machines), poly tubing racks, tree shakers, and wreath clamp machines/tables.
- Customers in Hawaii, Alaska, Florida and parts of New England** will incur a small fuel surcharge, but this will only be the difference between the nearest free shipping point and your location. Please call for details. States affected: NY, MA, CT, RI, NH, VT, ME, FL, AK, HI.
- Special handling** fees, such as liftgates, non-commercial delivery and Saturday delivery not included. See next pages for fee schedule on these special services. NOTE: WE NEGOTIATE SPECIAL FEES WITH OUR FREIGHT CONTRACTORS AND PASS THESE SAVINGS ON TO YOU. IF SPECIAL SERVICES BECOME NECESSARY AT THE TIME OF DELIVERY, A HIGHER STANDARD RATE WILL APPLY.

Banners

- ✦ Heavy Duty Vinyl
- ✦ Unique High Visibility Graphics
- ✦ Full length sewn-in rope ties
- ✦ Grommets every 3-5'
- ✦ Maximum Durability

Our banners offer full-color, high quality, eye-catching graphics to attract the maximum attention to your tree lot. All color banners are made with heavy duty vinyl, and have grommets every 3-5 ft. (exceptions noted).

3' x 15' Vinyl



Vinyl
3'
x
8'



Frequently Asked Questions

Q: How should I attach and display my banner(s)?

A: The sturdy, full length rope ties and multiple grommets in our banners offer many options for displaying them. We have found that rubber or elastic cargo straps, which continually maintain tension on the material tend to work well. These can be hooked into the grommets. Be careful not to place too much tension on the grommets, as they may eventually tear out. Another option is to mount the banner to a flat object such as a fence, plywood, a cargo van or an existing sign. Our 4'x8' banners fit conveniently on a 4'x8' sheet of plywood or flakeboard.

Q: My banners are being affected by wind, can I cut wind holes in them?

A: Yes, half circle type wind holes will help relieve the "sail" effect on the banner. However, any modification may weaken the material and result in a tear.

CLOSEOUT PRICING

Vinyl
4'
x
8'



Vinyl
3'
x
8'



Banners

4' x 8'
Vinyl



made in the
USA

Customer
Attraction



3' x 12' Polyvista
Economy
Banner

is printed on bright white Polyvista,
8 mil, weather resistant plastic
grommeted every 3-4',
(less durable than vinyl)



**CLOSEOUT
PRICING**

**FRESH
CHRISTMAS
TREES**

Vinyl
3'
x
6'

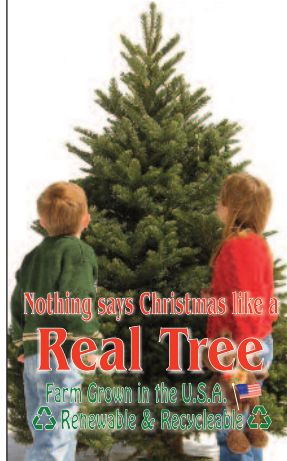

**CLOSEOUT
PRICING**

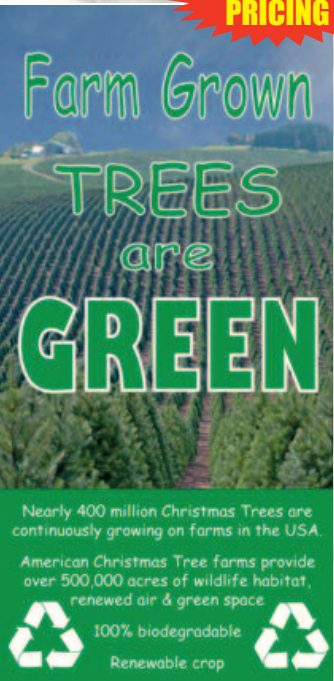

Vinyl
4'
x
8'

**CLOSEOUT
PRICING**

3' x 5' Vinyl

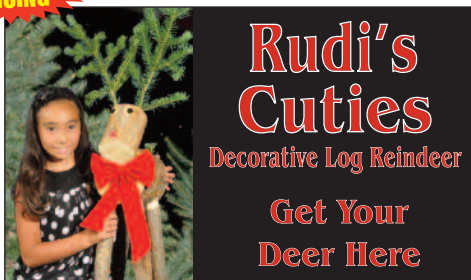

3' x 5' Vinyl



See next page
for more banners



Item	Code	Price
Fresh Christmas Trees 3x15' vinyl	B-FCT315	65.00
Snow Flocking 3x15' vinyl	B-SFLOCK	65.00
Choose and Cut 4x8' vinyl	B-CC48	25.00
Fresh Christmas Trees 3 x 8' vinyl	B-FCT38	48.00
Fresh Wreaths 3x8' vinyl	B-FW38	48.00
Farm Fresh Christmas Trees 4x8' vinyl	B-FARM48	52.00
Christmas Trees, Economy 3x12' Polyvista	B-Econ312	56.00
Fresh Christmas Trees (kids pic) 3x6' vinyl	B-KIDS36	20.00
Farm Grown Trees Are Green 4x8' vinyl	B-GREEN48	25.00
Rudis Cuties Banner, 3'x5' vinyl	B-DEER35	15.00
Flame Retardant Available Banner, 3x5 vinyl	B-FLMRT35	33.00

**CLOSEOUT
PRICING**

LIMITED QUANTITIES ON CLOSEOUT ITEMS

made in the
USA

Customer Attraction

3' x 15' Vinyl



3' x 8' Vinyl



8 ft. Shark Fin Flags



made in the
USA

Photo print on one side shows through on other side. Price includes 12ft fiberglass pole, stainless steel ground stake with ball bearing swivel, and canvas case (shown below).



8 ft. tall by 30 inch wide feather flags provide movement and attract immediate attention to your lot. Curved design holds flag open at all times, pole rotates in socket as wind direction changes, and includes tie down clip to keep flag on pole. Fits on heavy duty 12ft or 10.5ft segmented curved top pole with ground socket. Simply drive ground socket into desired location, pole and flag can be removed easily as needed.

Pennants



Triangle Pennants are made with durable, high visibility poly material, 50' plus 5' tie, triangles are 9" x 12". Add motion and seasonal colors to your location, letting customers know the nature of your business. Available in Christmas or Halloween colors.



Item	Code	Price
Pumpkin Patch Banner, 3x15'	B-PP315	65.00
Pumpkins Banner, 3'x8'	B-PKN38	48.00
"Christmas Trees" 8' Shark Fin Flag w/ 12' pole	FLAG TREES	105.00
"Pumpkins" 8' Shark Fin Flag w/ 12' pole	FLAG PUMPKINS	105.00
Christmas Pennant (60')	PEN-GRW	9.98
Halloween Pennant (60')	PEN-OB	9.98

Resale Items

Pursell's Tree Preservative

AMERICA'S #1 SELLING BRAND

BOLD NEW LOOK!



- ❄️ **Best money maker for tree lots**
- ❄️ **Provides nutrients to keep tree fresh**
- ❄️ **Highlights the importance of watering trees**
- ❄️ **Helps prolong needle retention**
- ❄️ **Scented with natural evergreen oils**

AVAILABLE IN 2oz and 8oz BOTTLES

2 oz liquid concentrate
makes 2 gallons

48 pack display box
Item Code: PRES2
OR

8 oz liquid concentrate
(pictured left)
makes 8 gallons,
24 pack in display box
Item Code: PRES8

made in the
USA



Resale
Items

Pursell's Christmas Tree Preservative has become a popular item for extra profits during the Christmas tree sales season. Millions of bottles sold! Mark up and sell outright near the cash register, or use the packets or handy 2 oz bottles as a promotional give-away item. Our own specially developed formula helps promote liquid absorption and combines with water molecules to reduce evaporation and promote needle retention. Contents include fiber softeners and essential nutrients and minerals to help maintain a fresher and safer Christmas tree. Natural evergreen fragrance in liquid preservative adds to the holiday experience. Liquid concentrate, UPC labeled, pet safe.

Oregon Forestry Laboratory Christmas Tree Preserver

Granular tree preserver from Oregon Forestry Lab. **Top Rated and Documented**, by Washington State Univ. Works better than water! Child & Pet Safe. Each packet contains a unique substance that absorbs water and expands into gel-like beads, allowing trees to absorb water back as needed without drying out or sealing. Other ingredients will keep needles on longer and tree moisturized. Suggested retail price \$3.00ea.



Display Case: 144 packets,
Item Code: PRESGRAN

Item	Code	Pack	Wholesale	>\$5,000	>\$10,000	>\$15,000
Preservative 2 ounce in display box	PRES2	48	.89	.85	.80	.76
Preservative 8 ounce in display box	PRES8	24	1.21	1.15	1.09	1.03
Tree Preserve Granular with display box	PRESGRAN	144	1.39	1.36	1.32	1.32

Resale Items

Resale Items



Removal Bags

made in the
USA

No More Needle Mess!

- ❄️ **Protects Floor from Spills & Stains**
- ❄️ **Makes Tree Removal Clean & Easy**
- ❄️ **Can Be Used as Skirt to Cover Stand**
- ❄️ **Biodegradable**



Choose size and packaging:

Regular Size, 144" circumference x 90" tall
(nearly 4 ft. diameter by 7½ ft. tall)
.75 mil thickness

36 pack with colorful display box, (shown)
Item Code: RBDSP

50 pack bulk in box
Item Code: RBBLK

JUMBO SIZE - 144" circumference x 114" tall,
(nearly 4 ft. diameter by 9½ ft tall), .75 mil
48 pack bulk
Item Code: RBJUMBO

Color display boxes for
regular bags, RBDSP



Retail Flock

Do It Yourself Flock allows your customers to make Christmas magic! Great for winter landscapes or snowy highlights on trees, wreaths and greenery. Self-Adhesive, sticks instantly with water, just spray with water as dusted on to desired surface directly from the jug with the dispensing cap. Net Volume 160 oz each, 12 pack floor display box. Item Code: FLKJUG



Pull Bows

Simply pull the string and watch a perfect bow appear. Packaged neatly as bundled ribbon, these bows take shape (and added space) only when you are ready. Convenient and compact! Choose from 2 sizes of red velvet bows: 5.5" diameter, 18 loop, 24 pk (BOWPBV9SM), or 8" diameter, 20 loop 24pk (BOWPBV40LG)

more bows page 38



Item Code:
BOWPBV9SM



Item Code:
BOWPBV40LG



packaged
pull bow



Resale Items

Floor Mats



Tree-sorb: Customers can protect their carpet and floors from spills with this 30" diameter water-proof mat, each of which can absorb up to 45 ounces of liquid. Made of 3 layers of absorbent fabrics and protective barriers, these durable mats come in an attractive 24 pack countertop display case. Item Code: TSORB

Spray Snow



Santa Snow is great for frosting wreaths, trees, decorative boughs, or window decorations. Touch-up a flocked tree or create winter decorations with the press of a finger. UPC labeled. 13 oz can, 12 pack. Item Code: SSNOW

Watering Funnels



Full height floor display

24 pack

Item Code: WFUNNEL

Wreath Hangers

Brass, Black, Gold



Fits easily over both exterior and interior doors with no nails, no tools, and no hassle. Provides attractive and simple way to display wreaths and greens on doors. Door decorations are popular all year long, so be sure to stock these hangers accordingly. Bulk boxed in 25 pack, available in brass, black or gold. Item Codes: WHBRS, WHBLK, WHGLD

Item	Code	Pack	Wholesale	>\$5,000	>\$10,000	>\$15,000
Removal Bags, regular with display (36 pack)	RBDSP	36	1.25	1.19	1.13	1.06
Removal Bags, regular BULK	RBBLK	50	1.15	1.09	1.04	.98
Removal Bags, JUMBO	RBJUMBO	48	1.49	1.42	1.34	1.27
Retail Flock, 160 oz Jug	FLKJUG	12	8.25	7.84	7.43	7.43
Pull Bow, velvet #9, 5.5 dia	BOWPBV9SM	24	1.71	1.71	1.71	1.71
Pull Bow, velvet #40, 8" dia	BOWPBV40LG	24	3.05	3.05	3.05	3.05
Tree-Sorb Mat w/ display	TSORB	24	4.25	4.04	3.83	3.83
Santa Spray Snow	SSNOW	12	2.25	2.14	2.03	2.03
Watering Funnels	WFUNNEL	24	3.95	3.83	3.71	3.71
Wreath Hanger, gold	WHGLD	12	1.65	1.60	1.55	1.55
Wreath Hanger, black	WHBLK	12	1.65	1.60	1.55	1.55
Wreath Hanger, brass	WHBRS	12	2.35	2.28	2.21	2.21

Volume price breaks are based on combined order total for each shipment. See page 7 for details.

FREE SHIPPING
on orders over \$2,500 (see page 7 for details)

Resale
Items

Log Reindeer & Snowmen

“Best ‘add-on’ item I’ve seen in 25

Add a new and unique dimension that sets your tree lot apart with these adorable decorative reindeer and snowmen, and double your money. Available in 3 sizes each, these hand crafted log characters bring new customers to your lot and are an easy add-on sale for customers looking for trees. Comes completely assembled including holes for antlers, tail or arms. Boughs/decor not included. Use boughs from your lot or other foliage to add antlers, tails, arms and your own unique character elements to your reindeer herd or flock of snowmen. Manufactured under 2012 Copyright and US Patent #D729,687

- ❄ **Irrisistably cute**
- ❄ **Proven seller coast to coast**
- ❄ **Customizable characters**
- ❄ **Indoor or outdoor decor**

Rudi's
Cuties



**PROVEN
SELLER**

**Each available in
three sizes (shown)**

Small Snowmen (14"-18" tall)
Medium Snowmen (18"-23" tall)
Large Snowman (24"-30" tall),
Hand made, sizes vary,
arms not included.

DECOR
(sold separately)
Berries (nose),
bows and ribbon
(scarf) are recom-
mended to up-
grade character
and saleability .
These and other
varieties appear
on pages 38-39



HANDMADE IN
COLORADO
**Reindeer
Ranch**™
BRAND WOOD ART
PATENT PENDING

**Decorate
your own
herd!**



20mm berries
HBR-LG



BOW-VALUE



RIBVEL9

medium deer
small snowman

Testimonials

“They are adorably cute and customers pick them out as if they were pets. We have been in the retail tree lot business for 15 years now and have been retailing the reindeer for 4 seasons.”

“We bought one combo bin of reindeer just to try them out. We sold out while we were setting up our lot on Wednesday before Thanksgiving. Unblievable! “ (Note: This customer ordered 3 times for a total of 12 bins during the 2011 season.)

“We sold over 1000 Reindeer at our 2 Colorado tree lots in 2010. The reindeer sell themselves and will increase your income tremendously.” (NOTE: This particular retail lot sold the small reindeer for \$25 and sold 1000 deer and 1500 trees)

“We did an inventory count of our reindeer and snowmen and I need to order more! They are so darn cute!”

“We love selling these at my lots. In my 28 years in retail trees, I have never seen items go snapped up like these deer and Snowmen. We have the reindeer displayed as a herd and snowmen displayed as a group near the checkout stand. Since they are natural wood, some have their own imperfections and marks which make folks want to adopt them more. While most are sold as an impulse buy, some customers buy another member of the ‘family’ each season until they have a complete set. They are also inclined to come back to my lot next year to get new ears and tails.”

**CLOSEOUT
PRICING** **3'X5' VINYL BANNER**



**Rudi's
Cuties**
Decorative Log Reindeer
**Get Your
Deer Here**

available on page 9.

Log Reindeer & Snowmen

years of retailing!"



spring/Easter



autumn



summer/4th of July

Add your choice of antlers Display and sell year round

Embellish your herd with a variety of foliage, boughs or other treatments for the season or occasion. Antler and tail holes are included on the deer so you can add the treatments or decor you prefer. (boughs not included)



Sold assembled as shown here

Available in three sizes:

small: 15-17" high 9-11" long	medium: 21-23" high 11-13" long	large: 26-30" high 14-18" long
-------------------------------------	---------------------------------------	--------------------------------------

(antlers not included in sizing or with product)

Environmental note: Logs used for reindeer are recovered from forest deadfall, not cut from live trees.

Rudi's
Cuties



Pricing & Packaging

Item	Code	Pk	Price	\$5,000	\$10,000
Reindeer, small	DEERSM	50	16.95	16.27	15.59
Reindeer, medium	DEERMD	32	22.50	21.60	20.70
Reindeer, large	DEERLG	24	30.50	29.28	28.06
REINDEER COMBO-BIN, 18-10-6	DEER COMBO	34	713.10	684.58	656.05
Snowmen, small	SNOWMN-SM	75	16.95	16.27	15.59
Snowmen, medium	SNOWMN-MD	50	22.50	21.60	20.70
Snowmen, large	SNOWMN-LG	24	30.50	29.28	28.06
SNOWMEN COMBO-BIN, 18-10-6	SNOWMN COMBO	34	713.10	684.58	656.05
MIXED COMBO BIN 10s-6m-4lg of both DEER & SNMN	D/S MIX COMBO	40	853.00	818.88	784.76

Reindeer and snowmen sold by the bin count. Smaller quantities of multiple sizes are also available in combo bins. Bins must be shipped by freight truck, not small package carrier.

FREE SHIPPING
on a \$2,500
total order.

see pg. 7 for details.

BIN QUANTITIES:

DEER	SNOWMEN
Small-50/bin	Small-75/bin
Medium-32/bin	Medium-50/bin
Large-24/bin	Large-24/bin

COMBO BINS:
34 DEER OR SNOWMEN

sm-18, med-10, lg-6
MIXED COMBO BIN:
DEER & SNOWMEN
sm-10, med-6, lg-4 of each,
40 characters total.

Cinco™ Stands

made in the
USA



Table Top, 12" diameter
fits trees up to 4' tall
with less than a 3" butt
Item Code: CTS163



Express Small, 16" diameter
fits up to 8' trees
with a 5.5" butt
Item Code: CTS152E



Express Medium, 20" diameter
fits up to 10' trees
with a 7" butt
Item Code: CTS148E



Express Large, 24" diameter
fits up to 12' trees
with an 8" butt
Item Code: CTS144E

With decades of proven reliability and features, Cinco™ stands are the premium plastic stand on the market. Made of sturdy plastic with metal hardware (except on table top), Cinco™ stands also feature patented towers which avoid conflicts with low branches, accommodate large tree butts, and provide a plentiful water basin. "Express" stands feature push-button slide bolts for easy installation.

- ❄ **No equipment required**
- ❄ **Easy "Express" installation**
- ❄ **Proven reliability**
- ❄ **Accommodates large trees**
- ❄ **Plentiful water basin**

CLOSEOUT



LIMITED QUANTITY

Cinco Advantage

A less expensive option for up to 6ft and 8ft. trees. Designed with tempered steel core plastic no-break bolt system. fits trees up to a 4" & 7" butt respectively
Item Codes: CTS156A CTS150A



Cinco "Express" Push -n- Slide bolts



We carry the *new and improved* Cinco "Express" stands: push top button to slide bolt, then crank to fully tighten—saving all that screw-turning time and effort.

Cinco™ stands available in "Classic" and "Advantage" versions, **ORDER EARLY, LIMITED SUPPLY!** (Priced Individually)

Item	Code	Pack	Whlsle	>\$5,000	>\$10,000
Cinco Table Top	CTS163	12	7.65	7.34	7.04
Cinco ADVANTAGE6	CTS156A	10	9.15	8.78	8.42
Cinco ADVANTAGE8	CTS150A	12	11.45	10.99	10.53
Cinco Express Small	CTS152E	12	15.00	14.40	13.80
Cinco Classic Small	CTS152C	10	15.00	14.40	13.80
Cinco Express Medium	CTS148E	10	19.75	18.96	18.17
Cinco Classic Medium	CTS148C	8	19.75	18.96	18.17
Cinco Express Large	CTS144E	6	26.50	25.44	24.38
Cinco Classic Large	CTS144C	5	26.50	25.44	24.38

Volume price breaks are based on combined order total for each shipment. See page 7 for details.

Tree
Stands

Noblett™ Stands

THE ORIGINAL!

made in the
USA



Mini 10
For <3ft. Trees
10" diameter
accepts 25mm
(1") tenons



Table Top 12
for 2-4 ft. trees,
12" diameter,
accepts 30mm
(1 1/8") tenons



Medium 14
for 4-5 ft. trees,
14" diameter,
accepts 40mm
(1 9/16") tenons

**Quick, Easy, and Inexpensive
way to stand Trees!**

Patented Noblett™ stands are a great way to quickly and economically stand trees from table top to about 7 ft. tall. Simply shape the butt of the tree with a tennon cutter (details below) and press the butt into the stand for a tight fit. Noblett stands are shaped to hold water, and are available in three sizes. Butts should be shaped to appropriate diameter for the corresponding stand (detailed with each left).

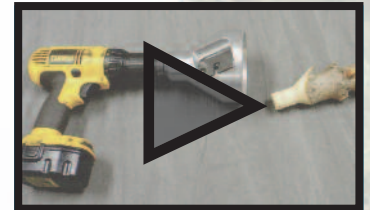

Visit our website
pursellmfg.com
for a video demonstration
of the Noblett Stand.

**CALL FOR SPECIAL PALLETIZED
AND TRUCKLOAD PRICING**

Item	Code	Pal Ct. /Pack	Wsale	>\$5,000	>\$10,000
Mini 10 Noblett Stand (10" dia base)	NTSMIN10	1,500	call	call	call
Table Top 12 Noblett Stand (12" dia)	NTSTT12	800 / 24pk	2.60	2.47	2.34
Medium 14 Noblett Stand (14" dia)	NTSMED14	512 / 20pk	5.00	4.75	4.50
Tennon Cutter 25 (25mm/ 1" dowel)	TC25mm	1	350.00	350.00	350.00
Tennon Cutter 30 (30mm/ 1 1/8" dowel)	TC30mm	1	350.00	350.00	350.00
Tennon Cutter 40 (40mm/ 1 9/16" dowel)	TC40mm	1	350.00	350.00	350.00
Tennon Cutter 50 (50mm/2" dowel)	TC50mm	1	350.00	350.00	350.00
Replacement blades (universal)	TCBLADES	1 set	59.00	59.00	59.00
Adaptor for 3/4" keyed shaft	TCADAPT	1	99.00	99.00	99.00

Volume price breaks are based on combined order total for each shipment. See page 7 for details.



Accurately sized tenons are produced quickly on tree butts with a Tennon Cutter and drill.

Pursell Tennon Cutters

- ✳ Specially designed for snug fit with Noblett stands
- ✳ Available in 4 sizes
- ✳ Limited depth to fit stand on first cut
- ✳ Fits any 1/2" chuck
- ✳ Removeable shank, can be fitted to other motors
- ✳ Dual blade for quick, even cutting
- ✳ Easy blade replacement



Adaptor for 3/4" keyed shafts allows tennon cutter to attach to motors like the one below.



replacement blades available for tennon cutter



Honda GX 160cc motor, 6:1 gear reduction



Mounted on frame with Tennon cutter and guard

motors are available from Northern Tool and Equipment at: www.northerntool.com item # 60326

Tree
Stands

GOLDEN™ SPIKE

Rebar Stands

ENGINEERED SPECIFICALLY FOR THE CHRISTMAS TREE INDUSTRY

- ❄️ Grade 5 hardened, zinc plated steel spike
- ❄️ Tapered and fluted spike for easy twist-off
- ❄️ State-of-the-art custom precision welds
- ❄️ No sharp edges on spike
- ❄️ Grade 60 rebar legs

*Manufactured in the USA from domestic steel
Meets or Exceeds standards for other brands*

Bowls, tips, and other accessories sold separately, see pages 19-21.

made in the **USA**

GSTT table top rebar stand
1/4" threaded spike,
3/8" rebar, 8 in. legs

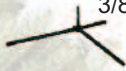

GSSM

Small Golden Spike
9/16" spike,
1/2" rebar, 10" legs



GSMD

Medium Golden Spike
9/16" spike,
1/2" rebar, 17" legs

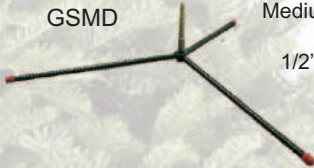

GSMD-SPR

Super Medium Golden Spike
9/16" spike,
5/8" rebar, 17" legs



GSLG

Large Golden Spike
9/16" spike,
5/8" rebar, 22" legs

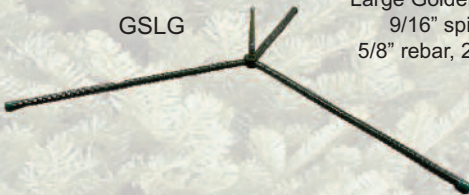

Large Reinforced Golden Spike
5/8" spike, 5/8" rebar, 22" legs

GSLG-RN



Jonah, Blaine and Brian working hard to produce our rebar stands.

TAPERED FLUTED SPIKE

Fits drill machines: matching taper between tapered drill machine bits and spikes, (must be driven in)
Stronger: Commercial 48" stands are made with our new hardened 5/8" solid golden spike
No Rust: Zinc coated to prevent rust



GSXLCOM

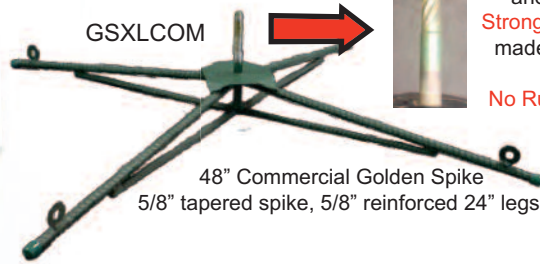

48" Commercial Golden Spike
5/8" tapered spike, 5/8" reinforced 24" legs.

GSSPRCOM

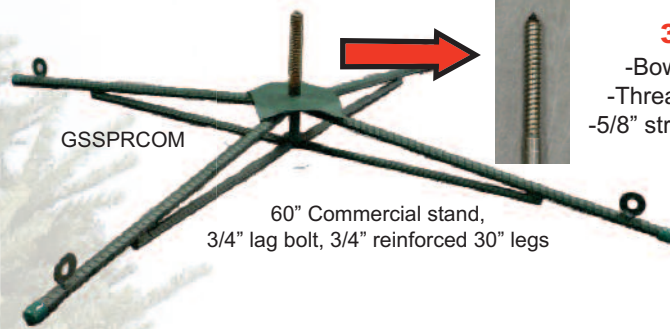

60" Commercial stand,
3/4" lag bolt, 3/4" reinforced 30" legs



3/4" Lag

-Bowls thread on
-Threads on to trees
-5/8" straight bit needed

Tree
Stands



Rebar Stands & Bowls

WBTT

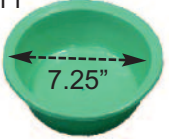
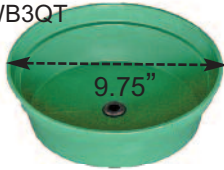

Table Top bowl,
1qt, self sealing

RWB3QT



Small Rebar bowl
3qt, grommet fits
1/2-9/16" spikes

made in the
USA

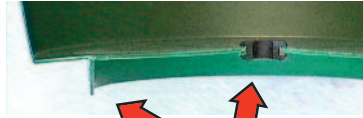

Cross section showing
reinforced support ring and
reinforced grommet area of
our medium and large
rebar bowls.



Medium rebar bowl showing
how the grommet fits and
seals over the spike.

RWBMD



Medium Rebar bowl,
6.5 qt, grommet fits
1/2-9/16" spikes



Replacement Grommets
-Regular: fits 1/2"-9/16" spike and
medium rebar bowl 100 pack, GRMREG
-Large: fits 9/16"-5/8" spikes and
large rebar bowl, 100 pack, GRMLG

RWBLG



Large Rebar bowl,
2.5gal, grommet fits
9/16-5/8" spikes

FOR SUPER 7gal BOWLS ONLY

-5/8" Commercial (5/8" Inside Diameter): replaces grommet in
Super 7 gallon bowl used on tapered pin 48" Commercial Stands
-3/4" Commercial (3/4" Inside Diameter): fits lag bolt on 60"
Commercial Stands and Super 7 gallon rebar bowl

RWBS7-58 or
RWBS&-34



Super 7 gallon bowl,
grommet fits
5/8" and 3/4" spikes
(must specify)

Grommets	Code	Pack	Price
Regular Grommets (fit 1/2" & 9/16" spike)	GRMREG	100	.42
Large Grommets (fit 9/16"-5/8" spike)	GRMLG	100	.45
5/8" ID Commercial, fits Sup 7 bowl & 48" stand ONLY	GRMS7-58	1	1.55
3/4" ID Commercial, fits Sup 7 bowl & 60" stand ONLY	GRMS7-34	1	1.55

**FREE
SHIPPING**

*on orders over \$2,500

(see page 6-7 for details)

**Recommended tree
sizes may not apply
to heavy trees**

STANDS

BOWLS

Item	Code	Tree Sz	Pack	Bowl Size	Bin Ct	Wsale	>\$5,000	>\$10,000	>\$15,000
Table Top Rebar Stand (8" legs)	GSTT	2-4'	5	TT 1 qt	NA	3.95	3.75	3.56	3.36
Golden Spike small rebar (9/16" spike, 10" legs)	GSSM	3-5'	5	small 3 qt	350	4.15	3.94	3.74	3.53
Golden Spike medium rebar (9/16" spike, 17" legs)	GSMD	6-8'	5	med 6.5 qt	250	6.85	6.51	6.17	5.82
Golden Spike Super Medium rebar (9/16" spike, 17" x 5/8" diameter legs)	GSMD-SPR	7-9'	5	med 6.5 qt	200	10.25	9.74	9.23	8.71
Golden Spike Large rebar (9/16" spike, 22" legs)	GSLG	9-11'	3	large 2.5 gal	120	11.00	10.45	9.90	9.35
Golden Spike Large Reinforced Stand (3-22" legs)	GSLG-RN	10-12'	3	large 2.5 gal	75	24.70	23.47	22.23	21.00
Golden Spike XL Commercial 48" 4 leg	GSXLCOM	11-13'	1	7gal+ 5/8" grommet	25	36.00	34.20	32.40	30.60
Golden Spike Super Commercial 60" 4 leg (with tips)	GSSPRCOM	14+16'	1	7 gal + 3/4 grommet	20	85.00	80.75	76.50	72.25
Table Top rebar bowl (1 qt self sealing)	WBTT		50	Recommended Bowl Size for each stand		1.19	1.13	1.07	1.01
Small spike bowl (3 qt w/ grommet)	RWB3QT		50		1.89	1.80	1.70	1.61	
Medium spike bowl (6.5 qt w/ grommet)	RWBMD		50		3.25	3.09	2.93	2.76	
Large spike bowl (2.5 gal) w/ grommet	RWBLG		25		4.75	4.51	4.28	4.04	
Super 7 gal spike bowl w/ grommet (specify 5/8 or 3/4)	RWBS7-58 or 34		5		10.50	9.98	9.45	8.93	

Volume price breaks are based on combined order total for each shipment. See page 7 for details.

ACCESSORIES ON NEXT PAGE

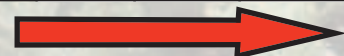

Rebar Accessories

Drill Machine

Item DM2

Drill a Christmas Tree straight the first time with this production lever-action Drill Machine. This machine is a must for all spike stand users. Centering device orients tree for perfect centered drilling with a tapered hole in any baled or unbaled tree. Comes complete with standard 3/4 H.P. 120 volt electric motor. Shipping wt 85 lbs. Note: this item is excluded from our free shipping program. See bottom of page 7 for details.



BITRND



BITFLT

Round or Flat tapered **Drill Bits and Chucks** for both 9/16" and 1/2" spikes. (Bits require compatible chucks)



CHUCKRND



CHUCKFLT

Note: 5/8" and 3/4" diameter straight bits for Commercial 4 legged stands are available at your local hardware retailer.

HAND DRILL ADAPTOR

Finally, an inexpensive way to drill a few trees for spike stands! Adaptor joins 5/8" bits with a 1/2" shaft to fit with most heavy duty hand power drills. Zinc plated to prevent rust. Item Code BIT-ADAPTOR

DRILL, BITS AND CHUCK NOT INCLUDED.



Adaptor with round chuck

requires round chuck (above) to attach bit to 1/2" drill

End Caps

To Protect Floors
100/pack

3/8" fits table top
1/2" fits small & med (red)
5/8" fits Super Medium,
Large & XL 48" (green)

Item Codes:
TIP38, TIP12, TIP58



Item	Code	Pack	Price
Drill Machine, Standard*	DM2	1	759.00
Round Tapered Drill Bit	BITRND	1	37.00
Chuck for Round Drill Bit	CHUCKRND	1	29.00
Flat Tapered Drill Bit	BITFLT	1	28.00
Chuck for Flat Bit	CHUCKFLT	1	37.00
Drill Bit Adaptor (1/2" to 5/8" adaptor)	BIT-ADAPTOR	1	4.50
3/8" End Cap (fits table top stands only)	TIP38	15	.22
1/2" End Cap (fits small & medium stands)	TIP12	100	.22
5/8" End Cap (fits large stands)	TIP58	100	.24

*Machinery items do not contribute toward price breaks or free shipping (priced from our location). However, if the balance of your invoice minus machinery cost totals over \$2,500, the machinery will be shipped free along with it.

Display Systems

GOLDEN™ SPIKE Display Systems

Golden Spike Display Systems allow trees to be displayed for sale (with water bowls) in a permanent configuration and replaced easily as they are sold. Design a custom arrangement to suit the space on your lot using either bolt through grid pins or spike plates. Rebar stands (with the same pin size) can be easily added to the trees as they are sold.

Grid Pins are 9/16" spikes with a 1/2" threaded shank so that they can be bolted through 3 inches of material, (the thickness of two 2x4's or 2x6's). Boards can be arranged in many ways to provide a permanent display system on your lot where trees can be added. Code: GRID PIN, 25 Pack boxed.



Spike Plates use a 9/16" spike, welded to a 4"x4" plate with holes on the corners for screws. Mounts easily to wooden planks, pallets, or a multitude of other configurations to display your trees with water bowls or without. Screws not included. Code: SPIKE PLATE, 12 pack boxed.



Grid Pin

Pricing Information Below

Display Arms

Display Arms: Simply snap a tree into the arm and your tree is displayed for sale. The 19 inch arm attaches to a 2x4 or 2x6 and is ready to use. Works great with flat bottom or large nail-on water bowls to keep trees fresh, see page 25. Use the arm over and over, year after year. Display Arms are made from heavy gauge, rustproof plated steel. 25/case.



Use pallets and 2x4 lumber to build a simple display system like the one shown here, including display arms for trees as well as wreaths. Center of display can be used to store extra tree inventory.



Flat bottom bowls work great to keep trees watered with Display Arms, see them on page 23.



Item Code
WB5QT

Item	Code	Pack	Whlsle	>\$5,000	>\$10,000
Spike Plates	SPIKE PLATE	12	4.14	4.03	3.90
Spike Grid Pins	GRID PIN	25	3.45	3.45	3.45
Display Arms	DA	25	8.35	8.10	7.85

Volume price breaks are based on combined order total for each shipment. See page 7 for details.

TRU-CUT™ Wood Stands



The Pursell family has been making wood tree stands for nearly half a century. We are #1 not just because of our prices, but because our quality is the best. Give us a try and see the difference.

ASK FOR TRU-CUT STANDS by name!

For decades, wood stands have been America's best selling Christmas tree stand, and our own TRU-CUT brand is the most reliable and sought after in the industry. TRU-CUT Wood Stands provide an inexpensive and highly profitable method of displaying Christmas trees on the lot and in the home. Don't fall for cheap imitations—quality counts! If inferior stands are not usable, they cost you money. TRU-CUT Wood Stands are recognized as the industry standard, and are used internationally by independent retailers and mass marketers. Stands are made from top-quality western soft-woods graded specifically for their intended use. Each piece is uniformly-cut, inspected, and stress-tested to help ensure 100% usability. (Bowls and nails sold separately)

THE MOST ECONOMICAL WAY TO STAND TREES!
100% USABILITY, SUPERIOR QUALITY
PRECISION UNIFORM CUT
MADE FROM PINE TO REDUCE SPLITTING
COLOR CODED--EASY SIZE IDENTIFICATION



Easy As 1, 2, 3

1. Trim tree butt perpendicularly to trunk
2. Insert primary nail into pre-drilled hole and place in position
3. Turn stand to an "X" position and secure with secondary nails

Tree
Stands



We make wood stands to fit any size tree, from 15" 1x2s for table top trees to large cleated stands for 12' and 15'+ trees



Large cleated stands include braces

Braces

Extra support for special applications
 Mitered to 45° and pre-drilled for easy assembly.
 Made from western soft-woods to prevent splitting.
 Available sizes from 10"-16" 1x1 and 18" 1x2
 14" or 16" Braces accommodate 6 quart bowl.
 18" 1x2 Braces accommodate a large nail-on bowl.



PRICING INFORMATION ON ADJACENT PAGE



Common Nails (smooth)

Nails are smooth common nails sold in 50 lb. boxes. Approximate quantity per box and recommended uses for each available size are outlined in the table below.

Nail Size	Code	Qty /Bx	Recommended Uses	W/sale	>\$5,000	>\$10,000
8d-2"	N0850	3500	small table top trees, braces	89.06	86.33	83.66
16d-3.5"	N1650	+/-2350	Primary for <6' trees, secondary nails	89.06	86.33	83.66
20d-4"	N2050	+/-1500	Primary for 6'-8' trees, secondary for 6'-10 trees	89.06	86.33	83.66
30d-4.5"	N3050	+/-1150	Primary for 8'-10' trees, secondary for >10' trees	89.06	86.33	83.66
40d-5"	N4050	+/-1150	Primary for 10'-12' trees	89.06	86.33	83.66
60d-6"	N6050	+/-550	Primary for 12'-15' trees	89.06	86.33	83.66

Recommended nail pattern shown.
 Note: flags or burrs on nails will damage bowls

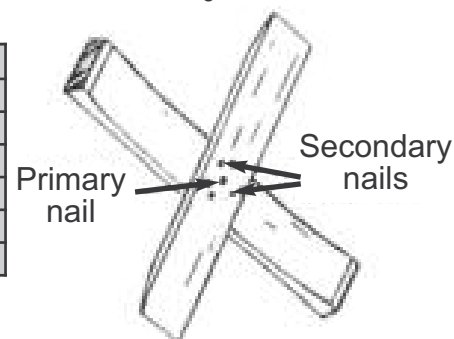

Nail-On Water Bowls

Add a TRU-SEAL Water Bowl to a TRU-CUT Wood Stand. Nail through the wood stand and bowl into the tree; elastic polymers will self-seal around the nails. A proven concept—millions used! For standard sized trees, choose the no-sag bottom for use with wood stands, or flat bottom for more versatility. Small and large sizes also available.

made in the
USA



The unique shape of our contoured bottom bowl prevents sagging and aids in centering for easier stand installation. Use with both 2x3 & 2x4 TRU-CUT wood stands

See our instructional video showing how to efficiently install wood stands and bowls at www.pursellmfg.com



Each batch of our bowls is rigorously tested for “sealability” and strength. Right off the production line, samples are frozen to -20°F, and a large spike is driven through them. We then check for a sure seal around the spike and make sure no splitting or other problems occur. If our bowls can withstand these harsh conditions and still provide a water-tight seal, they are sure to live up to their TRU-SEAL name on your tree lot!

Recommended tree sizes do not apply for large heavy trees

Item	Code	Color	Treesz	Pack	Wsale	>\$5,000	>\$10,000	>\$15,000
15" 1x2	WTS152		1-2'	20	.62	.59	.56	.50
18" 2x3	WTS183		3-5'	20	1.19	1.13	1.07	1.95
24" 2x3	WTS243		4-6'	20	1.54	1.46	1.39	1.23
30" 2x3	WTS303		5-7'	20	1.93	1.83	1.74	1.54
24" 2x4	WTS244		5-7'	10	1.80	1.71	1.62	1.44
30" 2x4	WTS304		6-8'	10	2.19	2.08	1.97	1.75
36" 2x4	WTS364		7-9'	10	2.70	2.57	2.43	2.16
36" 2x6	WTS366		9-11'	5	4.34	4.12	3.91	3.47
42" 2x6	WTS426		10-12'	5	4.58	4.35	4.12	3.66
48" 2x4 cleated w/ braces	WTS484C		10-12'	2	12.35	11.73	11.12	9.88
48" 2x6 cleated w/ braces	WTS486C		12'+	1	17.37	16.50	15.63	13.90
60" 2x6 cleated w/ braces	WTS606C		15'+	1	21.71	20.62	19.54	17.37
10" 1x1 braces	WTS10B	these sizes fit over water bowl		100	.22	.21	.20	.18
12" 1x1 braces	WTS12B			100	.25	.24	.23	.20
14" 1x1 braces	WTS14B			100	.33	.31	.30	.26
16" 1x1 braces	WTS16B			100	.36	.34	.32	.29
18" 1x2 braces	WTS18B			50	.65	.62	.59	.52
Table Top Nail-on Bowl	WBTT		trees 3' and smaller	50	1.19	1.13	1.07	1.01
3 qt. Small Bowl	WB3QT	3-6' trees	50	1.31	1.24	1.18	1.11	
5 qt flat bottom Bowl	WB5QT	trees from 5' to 9'	50	1.90	1.83	1.76	1.71	
6 qt no-sag Bowl	WBNS		50	1.90	1.83	1.76	1.71	
Large Nail-on Bowl	WBLG	trees from 9' -15'	25	4.21	4.06	3.89	3.79	
Sealing Pads, Regular, 6"	SP6		25	.53	.50	.48	.48	
Sealing Pads Large, 8"	SP8		25	.83	.79	.75	.75	
5qt Flat Bowl with 6" pad	WB5QT-SP6		50	2.66	2.65	2.58	2.53	
6qt No-Sag bowl with 6" pad	WBNS-SP6		50	2.66	2.65	2.58	2.53	
Large Bowl with 8" pads	WBLG-SP8		25	5.33	5.18	5.01	4.91	

Volume price breaks are based on combined order total for each shipment. See page 6-7 for details.

Table Top (1 qt) bowl
7" diameter
WBTT
IDEAL FOR 15" STANDS

Small bowl (3 qt)
10" diameter
WB3QT
IDEAL FOR 18" STANDS

Flat bottom 5 qt. bowl
12" diameter
WB5QT

Tru-Seal™ "no-sag" contoured bottom 6 qt. bowl, ****best seller**** (fits 2x3 and 2x4 stands only)
12" diameter
WBNS
TOP SELLER

Large (2.5 gal) bowl
WBLG
13.5" diameter
Tree Stands

Seal Pads
Peel & Stick



For those who want extra assurance! Peel the backing, and apply rubberized seal pad to bottom of any bowl. Available in regular 6" diameter and new larger 8" diameter, both 25 pk. Seal pads can be ordered separately, or pre-applied to your choice of nail-on bowls. To include pre-applied pads on your order, see descriptions and item codes near the bottom of the adjacent table.

PURSELL'S

BIGFOOT™

CHRISTMAS TREE STANDS

Shockingly Simple to Install!
just tap and crank... that's it.

Available in 5 different sizes for trees up to 20' tall. No drilling or special tools necessary, easy installation with the tap of a hammer and a crank will stand a tree straight in seconds. Once the stand is installed, simply lift the tree up to a vertical position and place over a water bowl (shown right). Tree is easily adjusted or straightened by bending slightly after installation. Bigfoot 15 and 20 come with two lag bolts for base of tree.

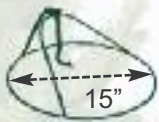

BTS 6
 For trees up to 6ft or 35 lbs
 cranks included

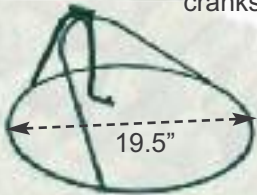

BTS 8
 For trees up to 8ft or 100 lbs
 crank included

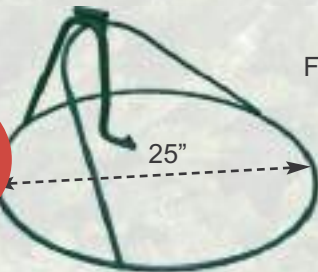

BTS 10
 For trees up to 10ft or 150 lbs
 crank included

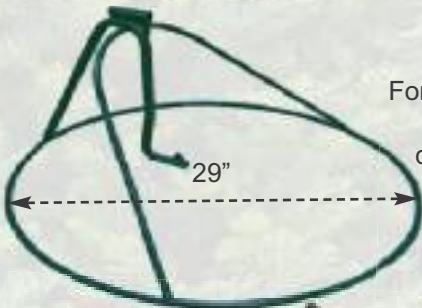

BTS 12
 For trees up to 12ft or 200 lbs
 crank included

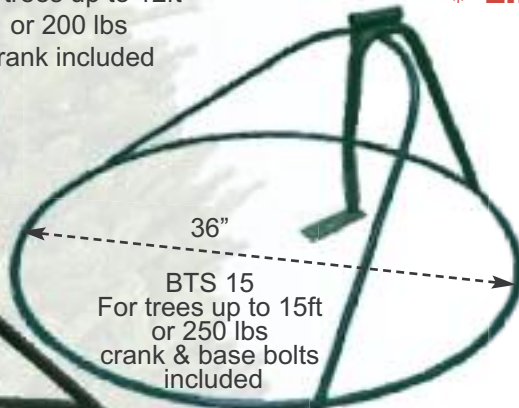

BTS 15
 For trees up to 15ft or 250 lbs
 crank & base bolts included

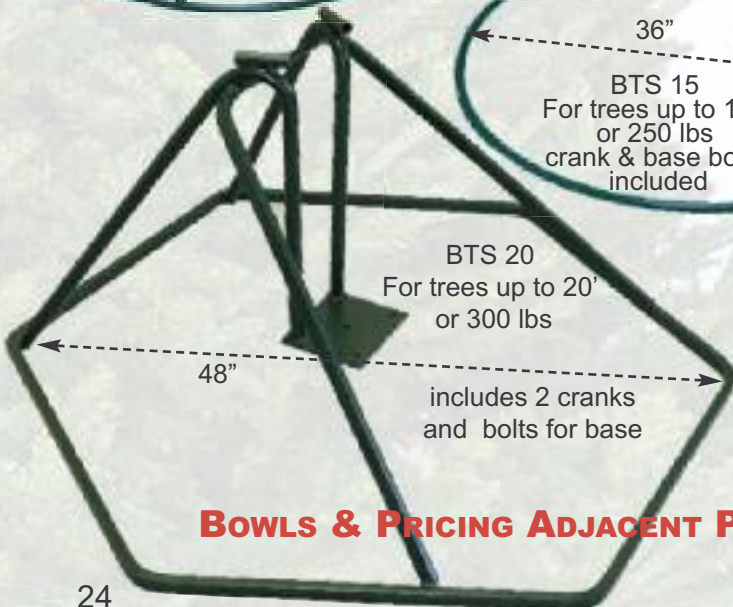

BTS 20
 For trees up to 20' or 300 lbs
 includes 2 cranks and bolts for base

made in the
USA

❄️ CRANKS INCLUDED

- ❄️ Fits easily over water bowl
- ❄️ Easy to straighten trees
- ❄️ Durable powder coating
- ❄️ Great for large trees
- ❄️ Lifetime Guarantee



BIGFOOT Attachment hardware: EXTRA Cranks and Bolts

- 3 sizes of each:
- Cranks for BTS size 6
 - Cranks or Bolts for BTS sizes 8-10 with 3/8" x 4.5" long lags
 - Cranks or Bolts for BTS sizes 12-20 with 1/2" x 6" long lags

BOWLS & PRICING ADJACENT PAGE



Thrifty Wire Stands



- ✿ Heavy Gauge construction
- ✿ Designed for strength when installed
- ✿ Push to straighten tree easily
- ✿ Quick mounting
- ✿ Fit in water bowls below

Stand Size	Code	Pack	Wsale	>\$5,000	>\$10,000
Thrifty Wire Stand 27" 3 legs, up to 6'trees	TTS27-3	25	7.25	7.07	6.89
Thrifty Wire Stand 27" 5 legs, up to 7' trees	TTS27-5	20	8.50	8.29	8.08
Thrifty Wire Stand 30" 5 legs, up to 9' trees	TTS30-5	10	13.25	12.92	12.59

Volume price breaks are based on combined order total for each shipment. See page 7 for details.

NOTE:
bowls sold
separately

Recommended bowl sizes:
BTS 6 - 3 qt.
BTS 8 - 5-6 qt.
BTS 10 - Lg.2.5 gal.
BTS 12-20 - Super 7 gal.

Water Bowls



Recommended tree sizes may
not apply to heavier trees



Tree
Stands



**LOOKING FOR A WAY TO
KEEP THOSE BIG TREES IN
WATER? LOOK NO FURTHER!**

The Super 7 gallon Water Bowl offers huge capacity for those large trees.

Works well with size 12 - 20.
Reinforced rim and bottom, 20"
across by 8" high.

Item/Tree Size	Code	Pack	Wholesale	>\$5,000	>\$10,000	>\$15,000
BIGFOOT Stand 6'	BTS06	1	14.30	13.80	13.16	12.87
BIGFOOT Stand 8'	BTS08	1	20.00	19.30	18.60	18.00
BIGFOOT Stand 10'	BTS10	1	28.00	27.02	26.04	25.20
BIGFOOT Stand 12'	BTS12	1	41.00	39.57	38.13	36.90
BIGFOOT Stand 15'	BTS15	1	83.00	80.10	77.19	74.70
BIGFOOT Stand 20'	BTS20	1	190.00	183.35	176.70	171.00
Extra Cranks 6	CRANK6	1	2.60	2.51	2.42	2.34
Extra Cranks 8-10	CRANK810	1	2.60	2.51	2.42	2.34
Extra Cranks 12-20	CRANK1220	1	5.30	5.11	4.93	4.77
Bolts 6-10 3/8"	BOLT-SM	1	.65	.65	.65	.65
Bolts 12-20 1/2"	BOLT-LG	1	1.10	1.10	1.10	1.10
Water Bowl 3qt flat	WB3QT	50	1.31	1.24	1.18	1.11
Water Bowl 6qt	WBNS	50	1.90	1.83	1.76	1.71
Water Bowl Large	WBLG	25	4.21	4.06	3.89	3.79
Super 7 Gallon Bowl	WBS7	5	10.50	9.98	9.45	8.93

Volume price breaks are based on combined order total for each shipment. See page 6-7 for details.

**FREE
SHIPPING***
*on orders over \$2,500
(see page 6-7 for details)

Finest Flock in the World

Names you know, Brands you trust

What's the Difference?

Our customers demand high quality flock products that apply easily, build quickly, look great, and stick well. Each of our flock blends use the highest quality low-dust fibers and adhesives. There are variations in the blends that offer higher build or better stick, or slightly different look. These variations are highlighted in the product descriptions. All of our formulations have been reliable for decades and are well-known brand names in **the Christmas Industry**.

If you have not tried our flock, please experience the difference. We guarantee it.



Pinnacle Flock™ the “flock in the blue bag” uses an old recipe from the 1950s developed by one of the pioneers of the flock industry, Jim Lightfoot. Pinnacle is formulated with our low dust high build fibers for extra fluff, and offers great color and adhesion. Packaged in our easy to handle moisture barrier bags with EZ zip opening feature. California State Fire Marshal registered and approved. 25 lb. bag, Code: FLK-Pinnacle



Our flock looks so much like real snow when applied that it is used for Christmas trees and greens, winter scenes, window displays and special effects in numerous motion pictures and television programs.



Marathon - 22™ The most trusted name in Flock since 1951, and our most popular flock brand. Blended with our low-dust formula, Marathon offers great color and yield with superior adhesion and flow. Gives you fast drying time without matting and increased productivity. California State Fire Marshal registered and approved. Packaged in moisture barrier bags, 25 lbs. each. Code: FLKMAR22



Criterion-33™ Our finest cellulose flock blended with mica flakes. Combines high quality super white flock with low cost. Fast flock buildup and more flocked trees per bag. Mica offers a sparkle effect. California State Fire Marshal registered and approved. Packaged in moisture barrier bags, 25 lbs. each. Code: FLKCRIT33

made in the
USA



Supreme-11™ Exclusive blend of finely cut high luster fibers and cellulose for a luxurious buildup. Has mica for sparkle and added customer appeal. California State Fire Marshal registered and approved. Packaged in moisture barrier bags, 25 lbs. each. Code: FLKSUP11

LIVE Flock for living organisms is specially formulated not to harm plants or burn foliage. The flame retarding component, which is required for most Christmas tree flock and which often harms living plants, is not included in this blend. 25 lb. bag. Code: FLK-LIVE

Special Effects snow as used in the movie and television industry to create winter scenes or for commercial applications. Use for indoor decorations such as store fronts and windows. It is readily cleaned up with a vacuum after use. 30 lb. bag. Code: FLK-SFX



Flock
Supplies

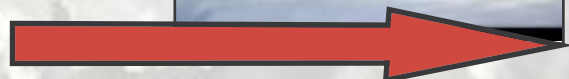

Colored Flock

made in the
USA

High Intensity Premixed Colors

Specialized Cotton blends produce bright, glossy, pure colored flock.
In 25 lb. bags. Item code FLK-(color)

Red
Sky Blue



Black
Royal Blue



Purple
Turquoise



Green
Lime Green



Pink
Yellow



Hot Pink
Gold
Orange



- ❄️ **100% COLOR FIBERS USED, NO FILLERS**
- ❄️ **QUALITY COUNTS!**
- ❄️ **GOES FARTHER, BETTER COVERAGE**
- ❄️ **THE SUPERIOR VIBRANT COLOR YOU DESERVE AND YOUR CUSTOMERS WILL LOVE**



Flock Pricing

Item	Code	Whsale	>\$5,000	>\$10,000	>\$15,000
Pinnacle Flock, 25 lb.	FLK-Pinnacle	28.25	26.56	24.86	23.17
Marathon-22 Flockbond, 25 lb.	FLKMAR22	29.99	28.19	26.39	24.59
Criterion-33 Flockbond, 25 lb.	FLKCRIT33	32.99	31.01	29.03	27.05
Supreme-11 Flockbond, 25 lb.	FLKSUP11	39.99	37.59	35.19	32.79
LIVE Flock, 25 lb.	FLK-LIVE	32.00	30.40	28.80	27.20
Special Effects Flock, 22 lb.	Flock-SFX	35.00	33.25	31.50	29.75
Colored Flock, 25 lb.	FLK-(color)	79.99	77.59	75.19	73.59

FREE SHIPPING

*on orders over \$2,500

(see page 6-7 for details)

Flock Effects

Opalina Pearlescent Flakes

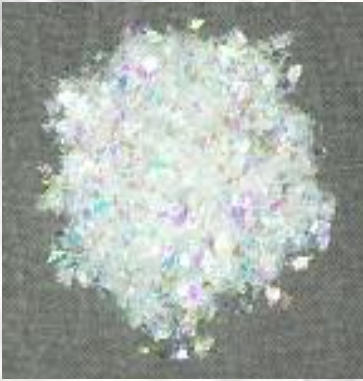

Trees shimmer and sparkle as these iridescent flakes pick up the colors of the spectrum just like fresh snow glistens in sunlight. Apply to tree after flocking. In 1 lb or 5 lb bags.

Mica Flakes



Make Christmas Trees gleam like fresh morning frost with naturally mined white Mica Flakes. Mica Flakes give an ice crystal effect like a real winter scene. For best results, sprinkle over wet flock to glue in. May be sprinkled on green trees or other decor as well, or mixed into the flock before application. 10 lb or 35 lb. lined box.



Flock Tint Colors

Dazzle your customers with intense color tints which can be added to your choice of flock to suit your coloring needs. Intensity depends on ratio blended with flock. Typically mixes with 25-50 lbs of flock for desired effect. 16 oz. canisters. Available in the following color choices: Red, Neon Magenta, Marine Blue, Neon Green, Strong Green, Turquoise, Yellow, \$9.50/canister, Code: TINT-(Color)

Colorant/Spray



Choose from a variety of colors: Red, Blue, Yellow, Green, and Black, or **mix these colorants to make shades in between**. Flock Colorant is easy to use, simply blend the powdered colorant with white flock to desired shade and apply the mix to the tree normally, or mix with water and spray on the color. Because it is often mixed with white flock, **colors tend to be more pastel**. Average 1-2 lb colorant to every 25 lb bag of flock (may use more for greater color intensity). Packaged in 1 lb canisters.



Glitter



Brilliantly colored and reflective glitter provides a dramatic effect to a flocked tree. Available in Gold, Silver, Red, Blue, and Green. This glitter is cut ultra-fine (nearly 4 times the number of flakes in ordinary glitter!) to yield more coverage on your trees. For best results, sprinkle glitter over a freshly flocked tree to create a firm bond. 1 lb bags.

Item	Code	Wholesale	>\$5,000	>\$10,000
Opalina Flakes 1 lb	OPAL1	8.25	8.04	7.84
Opalina Flakes 5 lb	OPAL5	40.00	39.00	38.00
Mica Flakes 10lb	MICA10	31.00	30.23	29.45
Mica Flakes 35lb	MICA35	104.00	101.40	98.80
Flock Tint Colors	TINT-(color)	10.00	9.75	9.50
Flock Colorant (all)	FC-(color)	10.00	9.75	9.50
Glitter (all)	GLTR-(color)	10.00	9.75	9.50

Pursell's SNOW FORCE™



**The Flock Machine
you've always wanted!**

Don't fall for cheap imitations. Ask for SnowForce by name

- ❄️ **Powerful two-stage blower motor, maximum flow**
- ❄️ **Cut your flock time by up to 75%!**
- ❄️ **Fully independently adjustable: flock, air, and water**
- ❄️ **Less expensive replacement parts (if ever needed)**
- ❄️ **Even flow without pulsing or globs**
- ❄️ **User mobility: 17+ ft. hoses, 20 ft. cords**
- ❄️ **Also available in 220v**

We've brought over 45 years of flocking knowledge together with related industry engineering to design and produce the most powerful and dynamic flock machine on the market--for less cost. We call it the "SNOW FORCE™" because the unmatched power is its defining characteristic. No blower motor in the industry even compares, much less offers the precision, flexibility or durability of Pursell's SNOW FORCE™. Our design team worked hard to include all the features and control you've always wanted, to go along with the durability you deserve and the production efficiency to get the job done promptly. See more details about these design features below and on the adjacent page.

made in the
USA

Comes complete with Snow Force machine and blower, agitator motor and system, Pursell's Blizzard™ Flock Gun, 17ft. material hose, 18 ft. water hose, 20 ft. remote motor switch, attached lid, dolly style handle and wheels. Holds 25+ lbs of flock. 120v A/C. 20" diameter by 39" tall.
Item Code: SNOWFORCE-110V, **\$1,795.00.**

**Also available in 220V, call for price.
(Does not contribute to free shipping)**

Pursell's "BLIZZARD" GUN FEATURES

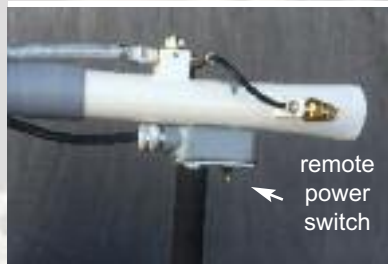
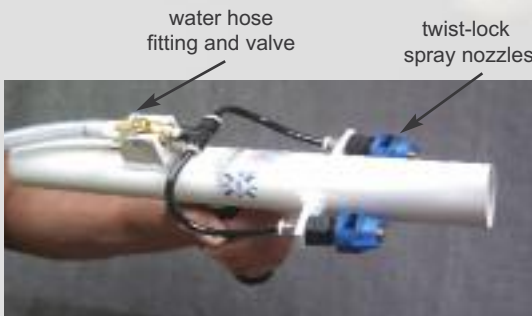

Low voltage remote toggle blower switch mounted directly on the gun puts control of the industry's most powerful blower motor at your finger tips. 17+ foot cords and hoses mean you can place your machine where you want it, and reach the tops of those big trees.

**see the Snow Force in action
with features demonstrated
at pursellmfg.com**

- Material flows straight through gun - no corners
- Water valve adjusts volume, includes quick-connect hose fitting
- Twist-lock dual side-fan converging angle water nozzles
- Ergonomic gun handle, no triggers or grips to fatigue hands
- Lightweight alluminum construction with brass fittings
- Easy to remove and clean
- Sold separately, available retrofit to other machines

Pursell's Blizzard Flock Gun with quick connect

Item Code: FLOCKGUNBLIZZARD **\$195***

(Does not contribute to free shipping)

Note: remote power switch included with machines, not on replacement blizzard guns.



FLOCK MACHINE

REVOLUTIONARY NEW DESIGN

Unlike any other flock machine

Compare the SNOW FORCE to the high capacity “Cadillac” blower systems. The SNOW FORCE blows those machines away with more power, lower cost components and superior design features.

Over
THREE TIMES
the output of other
“high capacity”
machines

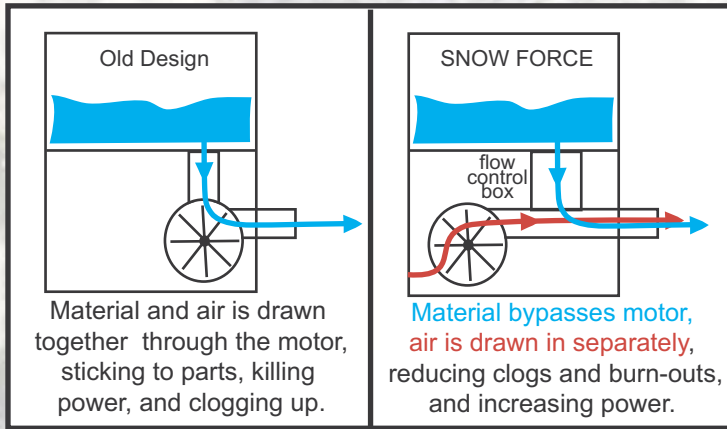

	SNOW FORCE	CAD BLOWER
Motor power	2.5 HP	1.25 HP
Time to blow 25lbs Flock (thru 17' hose)	4.5 minutes	16 minutes (thru 10' hose)
Material Flow Rate	zero-5.5 lbs/min	1.6 lbs/min
Blower motor cost	\$225	\$650.00+

Market Tested and Successful SNOW FORCE User Testimonials

- “Using the Snow Force is the easiest way to flock trees or anything else! The flow and adjustable controls help you do exactly what you want, using less flock compared to other machines. Does perfect flocking exist? I think so now!”
-Guillame Troisgros, Pyrofolies Effects, France
- “I cannot believe how much better the Snow Force performs. Fast, trouble free, powerful and simple to use.”
-Patrick Moriarty, Reindeer Forest, SoCal
- “Great machine, flocks a seven foot tree in half the time.”
-Peter Perino, Perino’s Nurseries, LA
- “In over 35 years of flocking--by far the best machine I have ever used.”
-Robert Heath, Heath Farms, Wisconsin
- “Trouble free and fast--a real money maker.”
-Ben Falk, T-Boys, Washington
- “My dad started flocking in 1975. He would have raved about the Snow Force. We like it so much we bought two!”
-Ted Thacker, Snowy Pines So Cal
- “I used to dread having to flock. The Snow Force proved to be a fast, easy, fun way to flock trees.”
-David Osteen, Clayton ValleyTrees, California
- “Regarding the Snow Force machine: I just wanted to say this is the best machine ever. I have been flocking trees for 25 years and was resistant to making the change to the new style machine. Now, looking back I wonder what took me so long? This machine delivers a consistent flow of product regardless of what setting you are using. The flow of water to the amount of flocking is perfect and I find I can flock more trees per bag and create less waste. I have used this machine for three years now and you couldn’t make me go back to the older machine. In that three years I have not once experienced a clogged hose or had to stop flocking because of being plugged up somewhere in the blower system. A wonderful machine that even inexperienced applicators will have great success with.”
-Phil Hunter, Wreath Works, Washington
- “Just as Pinnacle Flock is the best on the market, the Snow Force is the best flock machine on the market. They make a great team.”
-Frank Markes, Jay Waters, Inc., Washington

Flock Equipment

Pursell's Heavy Duty Turn Table

made in the
USA

- ❄ **Made for Production**
- ❄ **Built to Last**
- ❄ **Variable Speed**
- ❄ **Direct Drive**

Flock trees in as little as one minute with this turntable and the Snow Force flock machine, pg. 29



Inverted view of turn table drive



Item code: TTBL,
\$775.00 FOB*

direct drive motor and slip clutch shown

See our turn table in action on video at pursellmfg.com



Variable speed 0-10 RPM

- Direct drive w/ adjustable slip clutch, variable speed from 0 to 9 rpm.
- Electronic dial speed control with 15 ft. cord for wall mount, plus a 5 ft. power cord for 3 prong 115V A/C outlet.
- Fully enclosed .8 amps continuous duty 90V D/C gear motor, grease packed worm drive with steel and cast iron gears (not plastic!)
- 42" square, 3/4" waterproof 7 ply form board deck, 8 1/2" high
- Will accept even our largest 60" four leg stands (wood or rebar)
- 40x40 1 1/2" 16 gauge square tubing frame with end caps
- Four 5 inch support wheels, each rated for 250 pounds

Flock Supplies

CLOSEOUT

made in the
USA

The Pacemaker Flock Machine

Item PACEMAKER

Recommended for greens, wreaths or up to 30 trees per season—great for small operations, those getting started with flocked trees, or for using a separate machine for colors. Holds about 10 lbs of flock, includes Dayton brand .20 hp sleeve bearing, 10,000 rpm blower motor with toggle switch, metal center-spray "Surround Gun" (photo adjacent page), 9' material hose, spoked agitator, and adjustable flow.

Not recommended for more than 30 trees per season. **\$895.00 FOB***

CLOSEOUT ITEM, LIMITED SUPPLY



Tree Mover

Move heavy flocked trees with ease! We build these with thick-wall telescoping 1.5" steel tubing, adjustable height/length, notched fork for hooking under branches, and 10" pneumatic tires on ball bearing wheels. Tee-handle with grips, green enamel finish. Breaks down for off-season storage. Boxed, unassembled. 50 lbs. Item code: TMVR, **\$450.00 FOB***

made in the
USA

Fully Adjustable



*Machinery items (including flock equipment) do not contribute toward price breaks or free shipping (priced from our location). However, if the balance of your invoice minus machinery cost totals over \$2,500, the machinery will be shipped free along with it.

Flock Equipment

made in the
USA

Flock Machine Parts (for "Professional" and old "Cadillac" machines)



Dayton Blower Motor
.20 hp, sealed bearing, 120 volt. Item BLMDDT **\$160.00***

Brushes for Cadillac Motor
replaces brushes (contact parts) in Cadillac blower motor. *Try this before you throw that expensive motor away!*
Item BMBRUSH **\$25.00/2pk***



Replacement Brushes for Cadillac Blower Motor
BMBRUSH

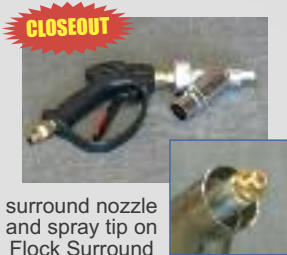

CLOSEOUT
surround nozzle and spray tip on Flock Surround Gun

"Surround" Flock Gun—
heavy duty metal body with center-spray "Flock Surround" nozzle for uniform application and adherence. Item: PROFLOCKGUN **\$179.00***

Hose Kit—10' water supply hose, material hose (1½" OD, 1¼" ID), and fittings. Item HOSEKIT-10 **\$70.00***



Hose Kit 10ft
HOSEKIT-10

Agitator Motor
6 rpm, 3/8" shaft, open fan, 115 volt, a/c, Works on "Professional" flock machines and other models, but not Snow Force. Item: AGMTR **\$160.00***



Agitator Motor
AGMTR

Cadillac Blower Motors
We still have a few in stock. Order early to get yours.
BLMCAD **\$650**



BLMCAD

**Don't see the part you need?
please call for details and availability**

SNOW FORCE Parts

Pursell's Blizzard Flock Gun
with quick connect for water hose. Will attach to standard material hose cuffs (typical 1.25" hose cuff fits inside gun) SNOW FORCE hose (2") fits outside. Item Code: BLIZZARDFLOCKGUN **\$195***



SNOWFORCE Blower motor, the FORCE behind the SNOW FORCE. 120v A/C, One year warranty. Will not work in other machines
Code: BLMSF. **\$225***



SNOW FORCE 17ft hose kit.
Includes superflex material hose with cuffs, water hose with screened brass fittings. *NOTE: will NOT work with standard machines or blowers, they are underpowered.* HOSE KIT-17 **\$125***



Hose Kit 17ft
HOSE KIT-17



Snow Force Air Intake Filter
Keep your important equipment running properly.
Filter media, universal size 8"x12"
(trim to fit.) **\$6.95**

Nozzle Kit
2 - Nozzle cap 2503 blue
2 - cap connection
Nozzle cap gasket (o-ring)
2 - 1/4" hose quick connector
\$99.00



Water Valve Kit
Shut off Valve
T-Connect, male
1/4" Male Quick Connect
\$55.00



Jet Kit
2 - Spray Tip 6501,
2 - Spray tip 6502,
\$110.00



blue nozzle cap not included in Jet Kit, shown for location or identification only

*Machinery items do not contribute toward price breaks or free shipping (priced from our location). However, if the balance of your invoice minus machinery cost totals over \$2,500, the machinery will be shipped free along with it.

Poly Tubing

made in the
USA

- ❄️ **Prepare Flocked Trees for Transport**
- ❄️ **Protect Flocked trees from Rain and Wind**
- ❄️ **Guard vehicles from Flock & Needle Drop**
- ❄️ **Continuous rolls individually boxed**



Poly Tube Size/Mil	Dia	Length	Apx tree ht	Code	Whsale	<\$5,000	<\$10,000	<\$15000
54" 1 mil thick	34"	500'	4-5'	POLY54	49.50	47.52	45.54	43.56
72" 1 mil thick	46"	500'	6'	POLY72	63.00	60.48	57.96	55.44
84" 1 mil thick	53"	500'	7-8'	POLY84	70.00	67.20	64.40	61.60
96" 1.5 mil thick	61"	500'	9-10'	POLY96	111.00	106.56	102.12	97.68

Available in Extra HEAVY DUTY below

Poly Tube Size/Mil	Dia	Length	Apx tree ht	Code	Whsale	<\$5,000	<\$10,000	<\$15000
48" 1.1 mil thick	31"	700'	3-4'	POLY48HD	98.00	94.08	90.16	86.24
66" 1.1 mil thick	42"	700'	5-6'	POLY66HD	122.00	117.12	112.24	107.36
78" 1.1 mil thick	50"	700'	7'	POLY78HD	141.00	135.36	129.72	124.08

Volume price breaks are based on combined order total for each shipment. See page 7 for details.

Easy Load Poly Tubing Rack

made in the
USA



Use top bar as a straight edge cutting guide.

- Holds three 48" rolls**
- Easy-load snap-in rods**
- Straight-edge cutting guide**
- Disassembles easily for storage**

Item Code: POLYRACK \$139.00

Flock
Supplies

Netting

COMPRESS AND PACKAGE YOUR TREES FOR EASY HANDLING

Customer Convenience

- Increase Profits**
- Reduce Labor**
- Easy to Use**



TNI knitted red and green netting



1" mesh

TNI Netting is packaged for shipment in bales of 3 cartridges each. A single bale of 23" TNI netting would be 3 cartridges at \$49.95 each, totaling \$149.85.

Volume discounts apply for invoices over \$5,000

Provide your customers with packaged Christmas trees for easy handling. A netted Christmas tree not only makes transporting simple, but also makes it easy to bring the tree through doorways without damaging the tree or house. It is like putting handles on the tree! The Christmas tree baling system provides an economical way to increase customer convenience and keep them coming back year after year. Choose from TNI knitted netting (below) or our extruded netting on the next page. Internationally standardized and ISO certified #9001-2008.



See our instructional video showing how to net trees at www.pursellmfg.com



TNI Advantage

- ❄ **Easier on trees**
- ❄ **Lays flat, easy disposal**
- ❄ **Easier on hands**
- ❄ **More compact 1" mesh**
- ❄ **Looks great on trees**

TNI netting sold by the 3 pack

3 cartridges at 1,040 ft. ea
1 bale = 3,120 ft.

Recycleable at level 2



Size	Pack	Item Code	Wholesale	>\$5,000	>\$10,000	>\$15,000
TNI Knitted Red & Green 1" Netting (yarn)						
16" x 1040'	3	TNI161040	36.95 cart / 110.85 3pk	34.18 cart / 102.54 3pk	31.41 cart / 94.23 3pk	29.56 cart / 88.68 3pk
18" x 1040'	3	TNI181040	42.50 cart / 127.50 3pk	39.31 cart / 117.93 3pk	36.13 cart / 108.39 3pk	34.00 cart / 102.00 3pk
20" x 1040'	3	TNI201040	44.50 cart / 133.50 3pk	41.16 cart / 123.48 3pk	37.83 cart / 113.49 3pk	35.60 cart / 106.80 3pk
23" x 1040'	3	TNI231040	49.95 cart / 149.85 3pk	46.20 cart / 138.60 3pk	42.46 cart / 127.38 3pk	39.96 cart / 119.88 3pk
26" x 1040'	3	TNI261040	56.50 cart / 169.50 3pk	52.26 cart / 156.78 3pk	48.03 cart / 144.09 3pk	45.20 cart / 135.60 3pk

Volume price breaks are based on combined order total for each shipment. See page 7 for details.

Knitted vs. Extruded: What's the difference?

Knitted netting is looped together in small links, making a strong fiber offering a soft feel in 1" mesh, which easily compacts for shipping and disposal or recycling at level 2, available in TNI's Red and Green striped. It is softer on hands, trees, and compresses for easier disposal.

Extruded netting is formed from stiffer continuous monofilament fibers, which are "welded" together every 2 inches (2" mesh), allowing for great compression and easy transport of the tree.

Netting

Extruded Netting

Pursell extruded opaque netting



2" mesh



made in the
USA

Extruded netting
sold by the 5 pack

5 cartridges at 700 ft. ea.
1 bale = 3,500 ft

Extruded Netting is packaged for shipment in bales of 5 cartridges each. A single bale of 23" netting would be 5 cartridges at \$29.50 each, totaling \$147.50. Volume discounts apply for invoices over \$5,000

Size	Pack	Item Code	Wholesale	>\$5,000	>\$10,000	>\$15,000
Extruded white 2" netting (monofilament)						
18" x 700'	5	P18700	30.50 cart / 152.50 5pk	29.59 cart / 147.95 5pk	28.67 cart / 143.35 5pk	27.45 cart / 137.25 5pk
20" x 700'	5	P20700	30.50 cart / 152.50 5pk	29.59 cart / 147.95 5pk	28.67 cart / 143.35 5pk	27.45 cart / 137.25 5pk
23" x 700'	5	P23700	31.50 cart / 157.50 5pk	30.56 cart / 152.80 5pk	29.61 cart / 148.05 5pk	28.35 cart / 141.75 5pk
26" x 700'	5	P26700	33.50 cart / 167.50 5pk	32.50 cart / 162.50 5pk	31.49 cart / 157.45 5pk	30.15 cart / 150.75 5pk

Volume price breaks are based on combined order total for each shipment. See page 7 for details.



LOOKING FOR A DEAL ON NETTING?

Our bright green 2" knit netting is an economic way to net trees. Available only in 23" variety, it features 2" mesh and a bright green color, and comes 1500 feet per cartridge, sold in a 2 pack. Code: GNET231500, \$40.00 per cartridge.

Compare, that's only 2.67 cents per foot!

Production Netting

ISO Certified #9001-2005



Knitted production netting is sold by the bale:
5 cartridges at 1,500 ft. ea. 1 bale = 7,500 ft.

TNI

Compress trees at the farm efficiently and economically for shipping. Production netting is available in red and green™, sizes 8", 10", 12", and 14".

Ask about our production baler ideas for smaller sizes such as production netting

Size	Pack	Item Code	Price
TNI Knitted Red & Green 1" Netting (yarn)			
8" x 1500'	5	TNI081500	28.78 / cartridge
10" x 1500'	5	TNI101500	33.61 / cartridge
12" x 1500'	5	TNI121500	38.09 / cartridge
14" x 1500'	5	TNI141500	44.15 / cartridge

Balers



BALERS are available in 4 sizes, corresponding to the four sizes of netting, 18", 20", 23", and 26". Recommended tree sizes listed in the table below are general, for fuller trees use a larger size. While our balers are more compact than others and there is some assembly required, balers ship in large boxes which may cost extra for ground shipments when shipped alone as a "small package".

made in the
USA



(netting sold separately)

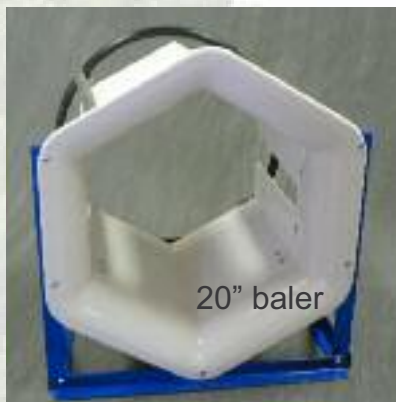

How It Works:

1. Start the tree base through the baler funnel,
2. Grip netting and tree trunk together,
3. Pull the tree through baler to apply netting,
4. Twist tree, then trim netting to desired length.

See our instructional video showing how to net trees at www.pursellmfg.com

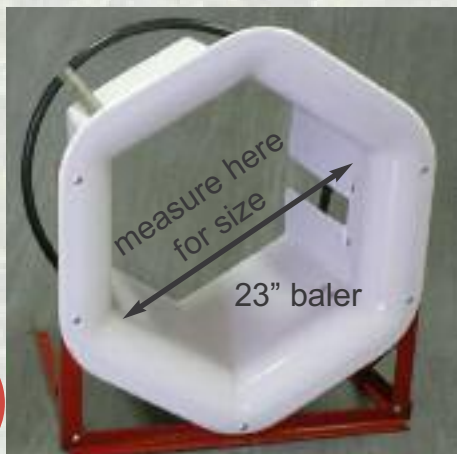

HOW TO MEASURE YOUR BALER

Baler size may be determined by color (see adjacent colors and sizes), or by measuring diagonally across the inside from corner to corner, (see photo of 23" baler, left).

Our new baler design will **save you money on shipping!** Until now balers would cost nearly **3 times normal ground shipping rates** because of their bulky design and large box. But with our new compact design, ground shipping costs have been cut, and we pass those savings on to you. Minimal assembly required (13 bolts).

NEW DESIGN

Baler parts now available:
retainer rings & spring clips, pricing below

Size	tree size	Item Code	Price
18" Baler	4-5' trees	BLR18	280.00
20" Baler	5-7' trees	BLR20	280.00
23" Baler	7-9' trees	BLR23	299.00
26" Baler	8-10' trees	BLR26	340.00
Retainer Rings	specify	BLRRING-(SIZE)	12.00
Baler Clips (one size)	sold individually	BLRCLIP	3.00

Volume price breaks are based on combined order total for each shipment. See page 7 for details.

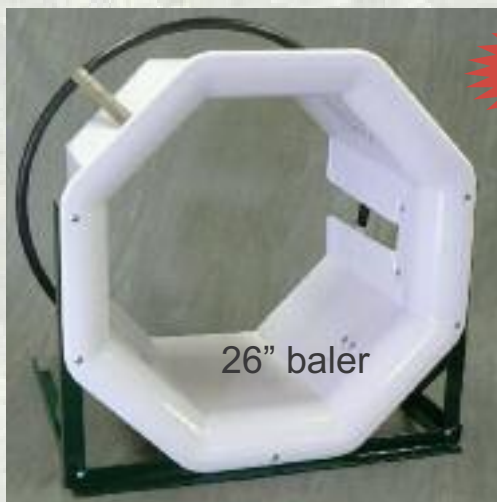

Wreath Rings & Clamps

We proudly offer Mitchell Wreath Rings™, and the Mitchell “No-Hammer”™ Clamp Machine and stand. Discover why many customers have said, “I tried rings that look like yours, but there is something different about Mitchell rings. I don’t know what it is, but it sure makes a difference.”

Experience the Mitchell difference - the result of 55 years of experience in the wreath ring manufacturing business. Mitchell's rings and specialty shaped clamps are unique for three reasons:

- 1) Specially selected high quality wire.
- 2) Unique custom drawn wire and steel formulation for clips to prevent spring back after clamping.
- 3) A patented production process to assure strong welds between these two distinctly different kinds of steel.



Wreath rings are available in round: 8”, 10”, 12”, 14”, 16”, 18”, 20”, 24”, 30”, 36”, & 48”. (NOTE: actual wreaths will be LARGER than rings. For example, a 12” ring may produce a 24” wreath, depending on foliage used.)

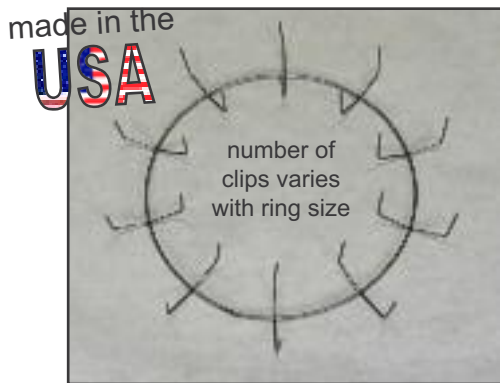

Specialty shaped clamps



Craftmaster II

Table-mount No-Hammer™ Wreath Clamp machine. Hand activated for low volume production. Simply bolts or clamps on to most tables, attaches greens and decor to wreath rings by using the hand lever.

The Mitchell “No Hammer” Wreath Clamp Machine™

Flattens and closes ring wires as shown in one easy step - no more hammering those protruding wires. Wreath Clamp bolts easily into the Metal Stand designed to house the clamp. The stand has a durable powder coat finish and rust resistant 31” x 46” aluminum top, and disassembles easily. Just push the pedal to clamp anything from evergreens to dried flowers.

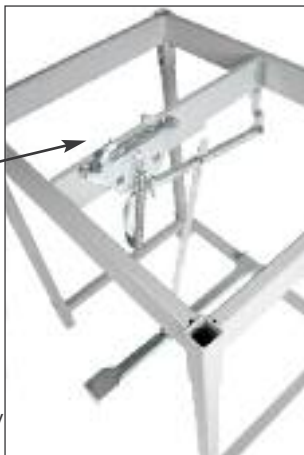

Clamp Machine

assembled (includes pedal mechanism)

Clamp Stand

(Table top included but not shown)

Clamp machine and stand sold separately

Advent Rings 10” (holds 4 candles)

Size	Code	Pk	Guage	Clips	Whsl	>\$4K	>\$8K
8” Wreath Ring	WR08	100	10g	8	.59	.57	.55
10” Wreath Ring	WR10	100	10g	10	.64	.62	.60
12” Wreath Ring	WR12	100	10g	12	.78	.76	.73
14” Wreath Ring	WR14	100	9g	14	.94	.91	.88
16” Wreath Ring	WR16	50	8g	16	1.12	1.09	1.05
18” Wreath Ring	WR18	50	7g	18	1.56	1.51	1.47
20” Wreath Ring	WR20	50	6g	20	1.77	1.72	1.66
24” Wreath Ring	WR24	50	6g	24	2.14	2.08	2.01
30” Wreath Ring	WR30	25	2g	30	4.49	4.36	4.22
36” Wreath Ring	WR36	15	0g	36	7.78	7.55	7.31
Candy Cane (turns Left 24”)	WRCC24	25		12	2.75	2.67	2.59
Cross 18”	WRCROSS18	25			2.65	2.57	2.49
Cross, 24”	WRCROSS24	25			2.93	2.84	2.75
8” door swag	WRSWAG	25		6	.44	.43	.41
Mailbox Frame	WRMB	25		7	2.75	2.67	2.59
Advent Ring, 10” CLOSEOUT	WR-ADVENT	30		8	4.10	3.98	3.85
Craftmaster II Clamp Machine	WCRAFT	1			53.00	53.00	53.00
“No-Hammer” Clamp Machine*	WMACHINE	1			187.00	187.00	187.00
“No-Hammer” Clamp Stand*	WSTAND	1			350.00	350.00	350.00

Volume price breaks are based on combined order total for each shipment. See page 7 for details.

Wreath Rings

Wreath Decor - Bows

Choose from our selection of gorgeous bows, favorites in the industry because of their hand crafted florist quality and appearance with full billowing loops. Add holiday color to your wreaths or other holiday decorations.

#40 Ribbon (2.5" wide), 6 radiating loops plus middle loop, 8.5" diameter, 14" tail, all pre-wired for easy attachment.

made in the
USA



Red weatherproof velvet 12pk



Burgundy weatherproof velvet 12pk



Traditional Plaid weather resistant 12pk



Gold glitter polysatin, weatherproof 12pk

Pull Bows

Simply pull the string and watch a perfect bow appear. Convenient and compact! Choose from 2 Red Velvet Bows.



5.5" diameter bow 18 loops #9 velvet ribbon



8" diameter 20 loops #40 velvet ribbon



packaged pull bow

Value Bow

Flattened, 8" dia with 12" tails and tie



Red velvet Imported

Ribbon #9



#9 ribbon (1.5" wide) available in velvet or plaid, 25yd roll.

Item codes: **RIB-VEL9, RIB-PLAID9**

XL and Jumbo Red Velvet Bows



XL

#40 (2.5" wide ribbon) 10 loop 12" diameter, 24" tails



JUMBO

#100 (4" wide ribbon) 10 loop 15" diameter 35" tails

Ribbon #40 (2.5" wide), 300 ft/roll



Choose from Polysatin (left) **RIB-POLY40**

or Red Velvet (rt) **RIB-VEL40**



weather resistant

Item	Code	Pack	Price
Red Velvet, #40 6 loop, 8.5"x14"	BOWRED	12	2.60
Burgundy velvet, #40 6 loop 8.5"x14"	BOWBURG	12	2.60
Traditional Plaid, #40 6 loop, 8.5"x14"	BOWPLAID	12	2.81
Gold Polysatin, #40 6 loop, 8.5"x14"	BOWGOLD	12	2.81
Value Bow, Red Velvet #40 4 loop, 8"x12"	BOWVALUE	48	1.44
XL Red Velvet, #40 10 loop, 10"x24"	BOWXL	6	5.17
Jumbo Red Velvet, #100 10 loop, 15"x35"	BOWJUMBO	4	10.16
Pull Bow, Regular 5.5" dia, #9 18 loop	BOWPBV9SM	24	1.71
Pull Bow, Large, 8.5" dia, #40 20 loop	BOWPBV40LG	24	3.05
#40 Red Velvet Ribbon, 300'	RIB-VEL40	1	35.15
#40 Red Polysatin Ribbon, 300'	RIB-POLY40	1	11.87
#9 Red Velvet Ribbon, 25 yd roll	RIB-VEL9	1	8.25
#9 Plaid Ribbon, 25 yd roll	RIB-PLAID9	1	11.87

Wreath Decor

Pine Cones

Decorate your wreaths, garlands, and other holiday décor with these durable natural Ponderosa and extra large pine cones. Ponderosa Pine cones (3½-4" long) are available in natural or white frost tipped.



Ponderosa Pine Cones



Frost Tipped Ponderosa Cones

Spray Snow



Santa Snow is great for frosting wreaths, trees, decorative boughs, or window decorations. Create winter decorations with the press of a finger. 13 oz can, 12 pack. Code: SSNOW

Wreath Novelties

(Imported)



Santa assortment, 3.5" santas with pick, 12 pack



Cardinals 3.5" in 2 varieties (both shown) 12 in pack



Large (20mm) berries on wire stems, 144 per pack

Hollyberry clusters red, with 7" pick



Fruit Pick, with red berries, a red apple, frosted cone, and frosted holly leaves, 12 pack



Lacquered red hollyberries and painted gold or silver hollyberries, 1/4" berry, 1.5" wire, 72 pair per pack

Picked clusters of balls, cones, gift boxes and drums in burgundy, gold, red & silver. Variety pack of 12, comes with 3 of each color.



Create your own picked clusters with tying wire wrapped over berry pairs



Tying Wire: tie branches up to keep trees looking great, or use for a multitude of purposes on your tree lot. see page 44 for details and pricing.

Prices shown for entire case pack

Item	Code	Pack	Price/pack
Ponderosa Pine Cone, natural, bulk	PC-POND	250	.39
Ponderosa Pine Cone, white tipped, bulk	PC-PONDWT	250	.59
Spray Snow	SSNOW	12	2.25
Fruit Pick-cone, apple, berries, frosted	WD-FRUIT PICK	12	16.95
Ball/Gift/Box decor assortment	WD-BGB	12	16.95
Santa assortment, 3.5" tall on picks	WD-SANTA	12	12.95
Cardinal assortment, 3.5" long	WD-CARDINAL	12	16.75

Item	Code	Pack	Price/Pack
Lacquered Hollyberries, red, paired on wire	HBRED	72 pair	2.50
Painted Hollyberry, gold, paired on wire	HBGOLD	72 pair	3.09
Painted Hollyberry, silver, paired on wire	HBSILVER	72 pair	3.09
Hollyberry Cluster, 7" pick	HBPICK	24	8.84
Large Hollyberries (20 mm) on wire stems	HBR-LG20	144	9.28

made in the
USA

Sales Tags

Weatherproof Tyvek Tags

Wired with Reinforced Hole, Consecutively Numbered



Two Part Sales Tag



Three Part Sales Tag



"Sold" Tag



Flock Tag



"Hold" Tag

2 Part Full Color Farm Photo Weatherproof Tag



3"x5.75" poly tag with elastic tie and consecutive numbers. Care tips and real tree info on back

Manage your inventory and track sales with consecutively numbered perforated tags. Sales Tags are size seven (2 7/8"x5 3/4")--large and visible) with reinforced holes, wire ties, and 100 per pack. Two part sales tags include tree care tips on the back, along with customer information blanks. Our most popular tags (above) are all made with tyvek, a weatherproof material that won't deteriorate with moisture like other tags. The Flame Retardant tag and Blank tag are made with cardstock (below).

Tree Shaped Tags

Tree shaped tags are made from durable poly plastic with a tuck through attachment. Highly visible with vibrant Christmas colors, tear off base for pricing and inventory management. Species specific tags include unique properties of each tree species. Real Tree marketing information and care tips included on back.



Species Tags

- Generic
- Canaan Fir
- Noble Fir
- Nordman Fir
- Fraser Fir
- White Pine
- Balsam Fir
- Scotch Pine
- Douglas Fir
- Spruce

Cardstock Tags



Flame Retardant Tag



Blank Tag

Security Ties

Attach your tags securely to your trees, eliminating potential for tag swapping on your lot. Ties are 4" long, 1,000 pk.



Item	Code	Pack	Material	Price
Two Part Photo Sales Tag	2PART-FC	100	Poly with elastic tie	.12
2 part Sales tag	2PART	100	Weatherproof Tyvek	.12
3 part Sales tag	3PART	100	Weatherproof Tyvek	.12
Flock tag	FLOCKTAG	100	Weatherproof Tyvek	.13
"Sold" tag	SOLDTAG	100	Weatherproof Tyvek	.13
"Hold" tag	HOLDTAG	100	Weatherproof Tyvek	.13
Flame Retardant tag	FLAMETAG	100	Cardstock	.10
Blank tag	BLANKTAG	100	Cardstock	.10
Tree Shaped generic	TREETAG	100	Waterproof Poly	.18
Tree Shaped Species	(Species)-Tag	100	Waterproof Poly	.18
Security Ties	STIES	1000	Plastic	.02

Lot Signs



24" w x 18" h

"H" Post Species Signs

Label your rows of trees with these high quality signs. 24" x 18" signs with bold print on corrugated plastic, fit on wire "H" frames (wire inside corrugation).

NOBLE FIR	Code: PSNobIF
DOUGLAS FIR	Code: PSDougF
FRASER FIR	Code: PSFrasF
NORDMAN FIR	Code: PSNordF
GRAND FIR	Code: PSGrandF
BALSAM FIR	Code: PSBalsF

24" w x 18" h



Wire "H" frames are 1/8" rod with 1/8" inserts, 30" tall (sold separately)

made in the
USA

Directional Signs

Large 22" x 14" signs help direct traffic in an orderly fashion in and out of your lot. Signs are printed in high gloss print on both sides of the corrugated core plastic, with universal arrows (flip sign over to point other direction).

Item codes: PSEnter, PSExit, PSPkg, PSOpen

- * Printed both Sides
- * Arrows both directions (flip for opposite direction)
- * Fits Wire "H" Frame



Wire "H" frames are 1/8" rod with 1/8" inserts, 30" tall (sold separately)

Item	Code	Price
"H" Post Species Signs, 24"x18" (specify type)	see disc above	10.50
Species Post Signs, 24"x24" (specify type)	see disc. above	10.50
General Lot Signs, 14"x22" (specify Enter, Exit, Pkg, Open)	see disc. above	10.50
Wire "H" Frames, 30" tall, sold individually	H Frame	3.15



TREE SHAPED TAG BLOWOUT!

Our 2018 tree shaped tags were not up to our quality standards. The material was a little lightweight and some tags tore easily. We have replaced this inventory for 2019 with new heavier material, but are selling off our limited quantity of tree shaped tags at a substantial discount. If this suits you, please inquire while inventory lasts.

PRICE: \$.10ea Tags/Species include:

- Generic Tags, Item Code: TREETAGCO
- Noble Fir, Item Code: NOBLE-TAGCO
- Nordmann Fir, Item Code: NORD-TAGCO
- Douglas Fir, Item Code: DOUGLAS-TAGCO



Customer
Attraction

Lot Lighting



100 foot light strings with 10 bulb cages

Designed for use on jobsites and locations where temporary lighting is needed for work areas during evening hours.

- 10 weather protected bulb sockets at 10ft intervals
 - UL approved, 110v, 15a
 - Yellow jacketed 12 gauge 3-wire strands
 - Molded vinyl coated metal lamp protectors
 - Linkable to 200ft, (wattage drop 8% with 100w bulbs)
 - Meets OSHA requirements for outdoor use.
 - Bulbs not included
- Code: LSREG, \$150.00



Commercial Light Stringer black wire, 108 feet, 50 sockets

- 120 volt black wire patio stringer
- E26 sockets, max 25 watts/ socket
- UL recognized components, tested for safety
- Use indoors or outdoors
- Compatible with both LED and traditional incandescent bulbs (check wattage)
- 10 amps - 16 gauge wire

\$95.00 Wholesale Price
(Choose matching bulbs below)
Code: LS-E26



LED Bulbs, E26 base (T50)

- Bulb base (E26) fits stringers above
 - Average bulb life: 60,000 hours
 - LED bulbs always remain cool to the touch
 - Nickel base prevents corrosion
 - Indoor / Outdoor use
 - Constructed with acrylic resin
 - 25 bulbs per box/bag
- Choose from: Warm White (shown right)
or Multi Color: Red, Blue, Amber, Green, Gold (left)

\$93.75 Wholesale per box of 25 (\$3.75/bulb)
Code: LS-Bulb-(W or C)



Strings and bulbs sold separately, choose bulb preference.

Commercial LED Rope Light, 150 feet, 120 Volt

(includes 3 splice connectors, 3 power connectors, 3 power cords, 3 end caps)

- Cut to desired length: three connectors included
- Long lasting bulbs, rated for 100,000 hours, provide years of use
- Enclosed in heavy duty PVC tubing for protection and flexibility
- UV resistant for outdoor use without the worry of fading
- Engineered for consistent lighting from first bulb to last so your lights maintain the same vibrancy throughout the entire tube
- Outline buildings, Wrap posts, signs, pathways, and more
- Rated for both indoor and outdoor use

Specifications: Bulbs spaced in 1 inch increments offer maximum brightness, Rating: CSA Approved, UL Listed
Voltage: 120 volts

\$179.00 Wholesale in Red or Warm White

Code: LS-Rope-(Red or White)



Burlap/Shade Cloth



Keep those valuable trees shaded, cool, and moist with burlap. An industry staple for decades, cover and/or wrap trees easily with our 12' wide by 50' long rolls of 7 oz. natural burlap. **\$126.00** per roll. Code: BURLAP1250

Use for Shade cloth



Covers Trees



Flame Retardant

made in the **USA**



Available in 5 gallon pails or 1 gallon jugs
5-6 8' trees treated per gallon (varies with size)

- ❄ **Spray on protection for trees, wreaths, greens, centerpieces, straw, etc.**
- ❄ **Reduces needle drop**
- ❄ **Water Based--Easy Clean-up**
- ❄ **Non-Toxic, child/pet safe formula**
- ❄ **Will not stain**
- ❄ **Guaranteed**

Don't forget certification tags (page 28) or this attractive 3' x 5' banner below (see page 40 for more details).

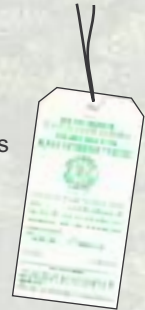

Make your customers' holidays safe!

Tree Safe Flame Retardant is truly a **SUPERIOR PRODUCT**. This high viscosity polymer formula not only goes farther than other brands, it **WILL NOT DEHYDRATE TREES OR GREENS** like salt-based retardants. **APPLICABLE TO INDOOR CHRISTMAS TREES, GREENS AND WREATHS**. Ordinary spray equipment applies a fine mist to your greenery, drying to a perfectly clear finish with no unsightly globs or residue. Tree Safe is odorless, non-toxic, child/ pet safe and water soluble for easy cleanup. Tree Safe meets national standards for Christmas Tree Flame Retardant and is registered for use by the California State Fire Marshall, California code: C-24101 **LOOK FORWARD TO 30-50% GREATER COVERAGE** than other brands! It will keep from season to season. Don't forget to order Flame Retardant Tags for your trees or wreaths too.



Misc. Lot Supplies

Item	Code	Pack	Price
Flame Retardant, 5 gal.	FR5	1	109.00
Flame Retardant 1 gal	FR1	1	23.00

Misc. Lot Supplies



Santa Hats: These soft plush Santa hats are perfect for identifying employees or just creating holiday cheer. One size fits most: 15" tall and approximately 24" circumference around inside of hat. Bright red hat with white trim and pom-pom. Sold individually, item code: HAT, **\$5.00 ea**

Aprons: An attractive yet functional apron for working on tree lots. Made from a high density, durable fabric that feels like cotton but is guaranteed to last twice as long. These aprons are fully adjustable, one size fits all, with three front pockets for supplies. Colorfast red with "Merry Christmas" embroidered on the chest, stain resistant, no ironing, no shrinking, sold individually.

Item Code: APRON, **\$15.00 ea**



Coloring Books: Inspire, educate and entertain children at tree lots with these creative coloring books which instill the value and environmental friendliness of real Christmas trees. 16 pages in each, assortment of 3 or 4 varieties as availability allows, 250/cs. Item Code: CB250, **\$.35 ea.**



Hand Tally Counter: The answer to your inventory woes! Count and inventory your trees or virtually anything else as they go by simply and easily with this durable hand-held counter. Sturdy steel case with chrome cover, features a four figure display, push button actuator for counting, reset knob, and finger ring for ease of use. Boxed individually. Item Code: TALLY, **\$11.00 ea.**



Snappy Trunk Tie Band: Why fumble with twine? Strap the car's trunk lid down for the trip home quickly and easily with this simple elastic band. 50/cs.

Item Code: SNAPPY, **\$.55 ea.**



Ring Knives: Makes cutting baled trees fast and easy. Cuts multiple types of twine or netting. Ring Size 12, 1 dozen knives per pack. Item Code: RKNIFE, **\$2.99 ea.**



Tying Wire: tie branches up to keep trees looking great, attach decor to wreaths or use for a multitude of other purposes on your tree lot. Choose from 3 varieties in bright or green:

-1/4 lb. (+/- 110') of 24 gauge, bright wire
Item Code: WIRE24, **\$1.50 ea.** **LIMITED SUPPLY**

-1.4 lb. (+/- 110') of 26 gauge bright wire
Item Code: WIRE26, **\$1.95 ea.**

-1/4lb. (+/- 110') of green 24 gauge
Item Code: WIRE24G, **\$2.75 ea.**



Item	Code	Pack	Price
Aprons	APRON	1	15.00
Santa Hats	HAT	1	5.00
Coloring books, assorted	CB250	250	.35
Tally Counter	TALLY	1	11.00
Ring Knives	RKNIFE	12	2.99
Snappy Trunk Ties	SNAPPY	50	.55
Tying Wire, 1/4 lb. bright	WIRE24	1	1.50
Tying Wire, 1/4 lb. green	WIRE24G	1	2.75
Tying Wire, 1/4 lb. bright	WIRE26	1	1.95

Misc. Lot Supplies



**NEW
IMPROVED
DESIGN**

Quick Tree Zip Tie LABOR SAVER!

Reduce time tying trees on cars with a quick tie down system. More secure than twine. Each tie down is 16 ft. long. Simply wrap around tree, slip the end through the locking mechanism and pull tight. Works with roof racks or loop through windows or doors.
Code: TREETIE 100/pk, \$.36 ea



Poly Twine:

Weather resistant and soft, two kinds to choose from:
Plastic wrapped or boxed, center pull.

Regular: 7,500' per roll, 75 lb. tensile strength, wrapped, or
Heavy Duty: 5,500' per roll, 210 lb. tensile strength, boxed
Item Codes: **TWINE-REG, \$15.50**
TWINE-HD, \$31.50

Regular
twine
plastic
wrapped
ball



Heavy
Duty
Twine,
individually
boxed



Shakee with
tree holder
(sold separately)

"Li'l Shakee" Tree Shaker

Make your trees "dance" for your customers as you help eliminate needle drop, one of the most common complaints about real trees. This electric 3/4 h.p. motor is field proven and comes with a 2 year warranty, along with standard foot switch and an optional tree holder. Shipping weight: 115 lbs.
Items: SHAKEE, **\$1,515.00*** SHAK-HLDR, **\$87.00**
****not available for free shipping program, sorry****

Item	Code	Pack	Price
Quick Tree Zip Tie, 16 feet	TREETIE	100	.36
Poly Twine, Regular, 7,500'	TWINE-REG	1	15.50
Poly Twine, Heavy Duty, 5,500'	TWINE-HD	1	31.50
Li'l Shakee tree shaker*	SHAKEE	1	1,515.00*
Tree holder for shaker*	SHAK-HLDR	1	87.00

*Machinery items (including Li'l Shakee) do not contribute toward price breaks or free shipping (priced from our location). However, if the balance of your invoice minus machinery cost totals over \$2,500, the machinery will be shipped free along with it.

FREE SHIPPING
on orders over **\$2,500** (see page 6-7 for details)

Misc. Lot
Supplies

Grower Supplies



Tree Colorant

Ultraviolet rays cause a yellowing process in some species of pines. This spells disaster for Christmas tree growers, since consumers seek a lush green tree. Years of research have gone into formulating O'Leary's Deluxe II Organic Tree Coating to enable you to take your trees to market with resilient deep green color. Deluxe II tree coating recolors the tree and blocks ultraviolet rays that cause yellowing. The color is harmless to trees and safe for the user. Once it is applied, it presents no hazards to children or pets and will not slow future growth. Soap and water cleanup. Dilute in water at up to a 1:30 ratio. One gallon of colorant, after dilution, will treat up to about 60 trees, depending on application rate. Comes in 2.5 gallon jugs \$62.50 Item Code: TC25

Load Divider

Eliminate receiving confusion for your drivers and customers by separating shipments. Versatile and useful for many applications, easy to handle 4.9 lb bales or in heavier duty 7.5 lb rolls, 1" mesh, recyclable at level II. Load Divider netting is 12ft x 375ft per case, Heavy duty red rolls or lighter weight red & green. Both are HDPE (soft plastic) knit. Lays flat for ease of use.



LOADDIVROLL
\$59.00ea

Load Divider ships in easy to handle bales at 375 ft each.

Choose from heavier duty high visibility red rolls sold individually (left), or red and green bales sold 6/case (right)



LOADDIVR/G
6 pack, \$49.00 ea

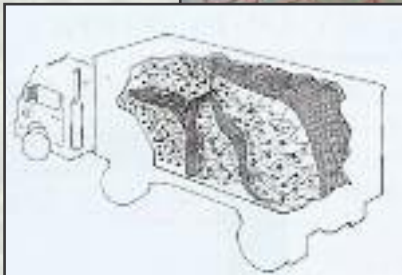
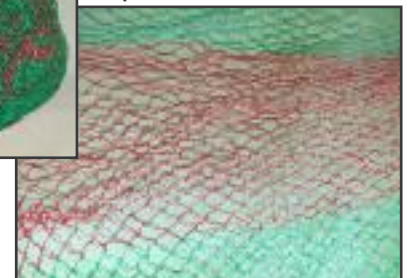

LIMITED SUPPLY ON CLOSEOUTS

Flagging Tape

Mark trees clearly with 24 varieties of tape, all 1³/₁₆ inch wide, length and price varies, see chart to the right. Rolls sold individually.



Solid colors, "Glo" colors, Striped, Checked and Polka Dotted



- Solid Colors:** Blue, Green, Orange, Pink, Purple, Red, Yellow
- GLO Colors:** Blue, Lime Green, Orange, Pink, Yellow
- Stripes:** yellow/White, Red/White, Green/White, Orange/White, Blue/White, Orange Glo/Black, Pink Glo/Black
- Dots:** Red/White, Blue/White, Pink Glo/Black, Orange Glo/Black

Item	Code	ft/roll	Price
Solid Colors	FTREG-(Color)	300	1.99
Glo Colors	FTGLO-(Color)	150	1.99
Stripes	FTSTRP-(Colors)	300/150-glo	2.25
Dots	FTDOT-(Colors)	300/150-glo	2.25
Checked	FTCHECK-(Colors)	300	2.25

LIMITED SUPPLY ON CLOSEOUTS

Pumpkin Carving Kits

**DON'T MISS OUT!
Double Your Money
Kids Love It!**

"We sold a carving kit
with every other pumpkin
at our patch last fall."
-Mountain Heights Pumpkin Patch



Deluxe Pumpkin Carving Kit: 1 scoop, 1 pumpkin saw, 1 ghost saw, 1 ghost pounce wheel, 1 drill, 10 carving patterns



2 Saw Kit



Family/Party Kit
2 Scoops, 2 Carving Saws, 2 Detail saws, 2 Pounce Wheels, 2 drills, 12 Patterns

**DEMONSTRATE
TO BOOST SALES!**



**CREATE ON SITE
"AGRI-TAINMENT"
ACTIVITY**

FREE SHIPPING

*on invoices over \$1,000**
*on Halloween items shipped within the continental United States.

Pricing

Item	Code	Pack	Price
Deluxe Carving Kit	PC-DLX	24	1.99
Family/Party Kit	PC-FAMILY	12	2.99
2 Saw Set	PC-2SAW	48	.59

VOLUME PRICING AVAILABLE

SCARY GOOD FREIGHT RATES!

**DON'T MISS OUR OTHER HALLOWEEN
PRODUCTS ON PAGE 10**



Presort Standard
US Postage Paid
Permit No. 154
Gunnison, CO

POB 248, Poncha Springs, CO 81242
1-888-487-8288, fax: 719-530-9097
order online at
pursellmfg.com



TIRED OF HIDDEN SHIPPING FEES?
FREE SHIPPING
on orders over 2,500*



*Exceptions to our free freight program apply in Florida, New York and New England, as well as Alaska, Hawaii, Canada, Mexico, and other foreign countries. Yes, we ship to these places, *free to the nearest free freight destination*. Customers will pay merely the difference from the nearest free freight location to your final destination. Certain machinery items are also exempted. Please see pages 6 & 7 inside for details.

